



FIRE PLACE

PELLET & WOOD | STOVE FAN KITS | BLOWERS
MOTORS | ACCESSORIES

www.alltemp.ca

2017/18

ALL NEW!!
24 Month Warranty
on all "HB-" Products

Buck Stove

Wood Stove R22CCW270ZD, 7163-5967, 7163-6045 (HM-R1138)
 Wood Stove R22CW206MD (HM-R1139)

HM-R1138
 illustrated



HM-R1139
 illustrated



Part #	HP	Volts	Amps	Type	Spd/RPM	Rot	Body	Frame	Bearing	Shaft
HM-R1138	1/50 1/80 1/140	115	.88, .60, .45	SP/ Open	3/1550	CCW	4.0"	3.9"	Sleeve	2.5"x5/16"
HM-R1139	1/50 1/80 1/125	115	.88, .61, .46	SP/ Open	3/1550	CCW	2.8"	3.3"	Sleeve	2.5"x5/16"x1.125"

HM-R1138 Band mounting, HM-R1139 Stud Mounting.



R7-RB440
 illustrated



R7-RB155
 illustrated



R7-RB447
 illustrated



R7-RB446
 illustrated



R7-RB445
 illustrated

Dayton, Grainger - Additional replacements on page 13 & 14

Part #	HP	Volts	Amps	Type	Spd/RPM	Rot	CFM	Frame	Bearing	Comment
R7-RB440	1/125	115	0.25	PSC/ Open	1/3080	CW	50	3.3"	Ball	1TDN7, 4C440
R7-RB155	1/40	115	0.75	PSC/TE	1/2480	CW	148	3.3"	Ball	Grainger 1TDR6, 4C006, Fasco 7021-4933
R7-RB447	1/25	115	0.77	PSC/ Open	1/1640	CW	273	3.3"	Ball	Grainger 1TDR3, 4C447
R7-RB446	1/20	115	0.75	PSC/ Open	1/3120	CW	146	3.3"	Ball	Grainger 1TDP7, 4C446, Fasco 7021-3469, Wood Doctor Furnace
R7-RB445	1/6	115	2.20	PSC/ Open	1/1430	CW	549	3.3"	Ball	1TDT2, 4C445, 4YJ32

R7-RB440 Includes intake screen guard, round discharge - round flange.

Elmira

Elmira Wood Stove 1500, 1600

Part #	HP	Volts	Amps	Type	Spd/RPM	Rot	Body	Frame	Bearing	Shaft
HM-R489	1/60	115	0.72	SP/ Open	3/1300	CW	2.5"	3.3"	Sleeve	3.6"x5/16"x3.5"



Elmira

Wood Stove Blower

Part #	HP	Volts	Amps	Type	Spd/RPM	Rot	CFM	Body	Frame	Bearing
R7-RB34	1/25	120	0.60	ECM/Open	1/2800	CW	73	6.6"	3.3"	Ball

HB-RB34 Includes intake screen guard, built-in variable speed control, 3-prong plug, round discharge - large square flange.



Elmira

Elmira (Wood Stove)

Part #	Watts	Amps	Volts	RPM	Rot	CFM	Blower	Blower Wheel	Bearing
HB-RB200T	35	0.60	115	1600	CCW	200	15"x4.25"x4.25"	65x240mm (2.6"x9.4")	Sleeve

HB-RB200T Features 8.3' cord & 3 prong plug.



Enviro

Enviro EFW261, EF1000, 1600, 2160, 1200, 1700

Part #	Watts	Amps	Volts	RPM	Rot	CFM	Blower	Blower Wheel	Bearing
HB-RB261	50	0.80	115	1450	CW	130	16"x4.8"x4.25"	65x240mm (2.6"x9.4")	Sleeve



Enviro

Enviro 50-2981, Q2 Gas Fireplace

Part #	Watts	Amps	Volts	RPM	Rot	CFM	Blower	Blower Wheel	Bearing
HB-RB981	50	0.82	115	2075	CCW	122	12.8"x4.6"x4.3"	76x101mm (3"x4")	Ball

Includes blower, mounting plate, thermal switch, and variable speed control.



OEM Replacement



Blowers, Motors & Fan Kits

ALL NEW!!
24 Month Warranty
on all "HB-" Products



Heat & Glo Blower Kit

Heat & Glo GFK-160A
 Fasco 7002-1241, A133

Blower Kit	Blower Only	Watts	Amps	Volts	Spd/RPM	Rot	CFM	Blower	Blower Wheel	Bearing
HB-RB168	HB-RB168B	53	0.92	115	1/2400	CCW	125	12.8"x4.6"x4.3"	76x101mm (3"x4")	Ball

HB-RB168 Includes blower with magnetic mounting, thermal switch assembly, variable speed control, wiring harness - cord with two prong plug.

Heatilator

Heatilator FK21 (Old Kit), GFK21 (New Kit)
 Novus 30, Security UZY3

Part #	Watts	Amps	Volts	Spd/RPM	Rot	CFM	Blower	Blower Wheel	Bearing
HB-RB21K	35	0.57	115	1/1800	CCW	80	8.0"x4.3"x3.6"	65x120mm (2.6"x4.7")	Sleeve

HB-RB21K Includes blower, thermal switch assembly, variable speed control - cord with three prong plug.



Heatilator

Heatilator FK4 (Old Kit), GFK4 (New Kit)

Part #	Watts	Amps	Volts	Spd/RPM	Rot	CFM	Blower	Blower Wheel	Bearing
HB-RB74K	50	0.86	115	1/1450	CW	130	12.9"x4.3"x3.6"	65x240mm (2.6"x9.4")	Sleeve

HB-RB74K Includes blower, velcro mounting strips, thermal switch assembly, variable speed control - cord with three prong plug.



Heritage

Wood Stove Blower

Part #	HP	Volts	Amps	Type	Spd/RPM	Rot	CFM	Body	Frame	Bearing
R7-RB34	1/25	120	0.60	ECM/Open	1/2800	CW	73	6.6"	3.3"	Ball

HB-RB34 Includes intake screen guard, built-in variable speed control, 3-prong plug, round discharge - large square flange.



Heritage

Heritage & Nordica Diamond Wall Furnace Blower
 Newmac Wood Furnace 2040001

Part #	HP	Volts	Amps	Type	Spd/RPM	Rot	CFM	Body	Frame	Bearing
R7-RB33	1/25	120	0.60	ECM/Open	1/2800	CW	73	6.6"	3.3"	Ball

R7-RB33 Features a built-in variable speed control & 72" cord with 3 prong plug.



Heritage

Heritage Wood Insert

Part #	HP	Volts	Amps	Type	Spd/RPM	Rot	CFM	Body	Frame	Bearing
HB-RB125	1/70	115	1.10	SP/Open	1/3200	CCW	125+	6.6"	3.3"	Sleeve



Heritage

Heritage 8011

Part #	Watts	Amps	Volts	Spd/RPM	Rot	CFM	Blower	Blower Wheel	Bearing
HB-RB82	42	0.72	115	1/1600	CW	110	10.5"x4.3"x3.6"	65x180mm (2.6"x7.1")	Ball

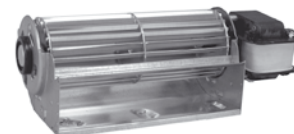

Hunter

Hunter - 770 (Kit), HDS2000, HDS3000, HFI30, HDV31, MGDV31, SFDV20 (Models)

Part #	Watts	Amps	Volts	Spd/RPM	Rot	CFM	Blower	Blower Wheel	Bearing
HB-RB68	50	0.86	115	1/1450	CW	130	12.9"x4.3"x3.6"	65x240mm (2.6"x9.4")	Ball

HB-RB68 Includes instructions, blower, mounting base, thermal switch assembly & variable speed control - cord with three prong plug.



Hunter

Hunter F125H, HWF30, HDV30

Part #	Watts	Volts	Amps	RPM	Rot	CFM	Blower	Blower Wheel	Bearing
HB-RB79	62	115	0.72	1200	CCW	150	15.7"x4.3"x3.6"	65x300mm (2.6"x11.8")	Ball

HB-RB79 blower only.



ALL NEW!!
24 Month Warranty
on all "HB-" Products

Hunter

Hunter Wall Heater 917254

Part #	HP	Volts	Amps	Type	Spd/RPM	Rot	CFM	Body	Frame	Bearing
HB-RB91	1/250	115	0.30	SP/Open	1/1500	CCW	50	5.5"	3.3"	Sleeve

HB-RB91 Includes round discharge - no flange.



Hunter, Napoleon, Valor

Fasco 7063-7735 Exhaust Blower

Part #	HP	Volts	Amps	Type	Spd/RPM	Rot	Body	Frame	Bearing
HB-RB735	1/125	115	0.36	SP/Open	1/1500	CCW	5.7"	3.3"	Sleeve

HB-RB735 Includes 3 prong plug, mounting nuts & bolts.



Kingsman/Marquis

Z33FK - ZDV3320 ZDV6000 - HB-RB37

F35FK - FDV350, FV, FDV5000, 4000 - HB-RB35

Z36FK - ZDV3600, ZDV4200N - HB-RB36

Part #	Watts	Amps	Volts	Spd/RPM	Rot	CFM	Blower	Blower Wheel	Bearing
HB-RB37	42	0.75	115	1/1400	CCW	110	10.5"×4.3"×3.6"	65×180mm (2.6"×7.1")	Ball
HB-RB35	50	0.86	115	1/1450	CW	130	12.9"×4.3"×3.6"	65×240mm (2.6"×9.4")	Ball
HB-RB36	50	0.86	115	1/1450	CW	130	12.9"×4.3"×3.6"	65×240mm (2.6"×9.4")	Ball

Kits include, blower, mounting base, thermal switch assembly & variable speed control - cord with three prong plug.



HB-RB36 illustrated



HB-RB35 illustrated



HB-RB37 illustrated

Kozy Heat

600-1, EM3030L-211

Part #	Amps	Volts	Spd/RPM	Rot	CFM	Blower	Blower Wheel	Bearing
HB-RB6001	1.22	115	1/1612	CCW	210	11"×3.75"×4.25"(2)	65×180mm (2)	Ball

Includes two blowers, mounting base, thermal switch, & 3 prong plug.



Lennox

FBK-250, BL65X, D-400, D-500, D-600, D-800, B-500, B-600, B-800,

MDT3328, MDR3328, Elite-2 Series, EDST-2, EDPF-2, EDCL-2, EDCR-2

Blower Kit	Blower Only	Watts	Amps	Volts	Spd/RPM	Rot	CFM	Blower	Blower Wheel	Bearing
HB-RB250	HB-RB100	50	0.86	115	1/1200	CCW	130	12.9"×4.3"×3.6"	65×240mm (2.6×9.4")	Ball

HB-RB250 blower, speed control/thermal switch assembly, cord - 3 prong plug.

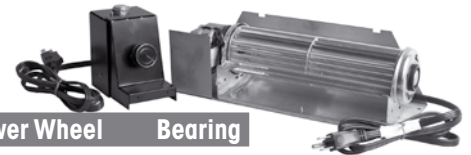

Majestic, CFM

CFM-FK30, Instaflame 52425

New Energy Distributing - AD1 Single

Part #	Watts	Amps	Volts	Spd/RPM	Rot	CFM	Blower	Blower Wheel	Bearing
HB-RB130	53	0.56	115	1/2800	CCW	70	8"×4.56"×4.32"	76×101mm (3×4")	Ball

HB-RB130 blower, magnetic mounting legs, cord - 2 prong plug.



Majestic, Vermont Casting, CFM

CFM - FK24 (fan only), RHE32, Lennox 18L46, Majestic HE30, HE32, Travis (Gas)

Part #	Watts	Amps	Volts	Spd/RPM	Rot	CFM	Blower	Blower Wheel	Bearing
HB-RB64	50	0.86	115	1/1450	CW	130	12.9"×4.3"×3.6"	65×240mm (2.6×9.4")	Ball

HB-RB64 blower only.



Majestic, CFM

CFM - FA20 (Model 1800), Majestic HE20 (Model)

Part #	Watts	Amps	Volts	Spd/RPM	Rot	CFM	Blower	Blower Wheel	Bearing
HB-RB82	42	0.75	115	1/1600	CW	110	10.5"×4.3"×3.6"	65×180mm (2.6×7.1")	Ball



OEM Replacement



Blowers, Motors & Fan Kits

ALL NEW!!
24 Month Warranty
on all "HB-" Products

Majestic, Vermont Casting, CFM

Majestic FK12

Part #	Watts	Amps	Volts	RPM	Rot	CFM	Blower	Blower Wheel	Bearing
HB-RB12	50	0.86	115	1450	CW	130	12.9"x4.3"x3.6"	65x240mm (2.6"x9.4")	Ball

Includes, cord, & 3 prong plug.



Majestic, Vermont Casting, CFM

Majestic FK24 (Blower), 33DBVRRN, DBT33,36,39, DBR33,36,39 (Model)
 Northern Flame FK24, A232, D232

Blower Kit	Blower & Base	Watts	Amps	Volts	Spd/RPM	Rot	CFM	Blower	Blower Wheel	Bearing
HB-RB65	HB-RB63	50	0.86	115	1/1450	CW	130	12.9"x4.3"x3.6"	65x240mm (2.6"x9.4")	Ball

HB-RB65 Includes blower, mounting base w/ foam strips, thermal switch assembly & variable speed control - cord with three prong plug.

HB-RB63 Includes blower with mounting base plate.



Monessen

Monessen BLOT

Part #	Watts	Amps	Volts	RPM	Rot	CFM	Blower	Blower Wheel	Bearing
HB-RB94	50	0.86	115	1450	CW	130	12.9"x4.3"x3.6"	65x240mm (2.6"x9.4")	Ball

Includes blower with Velcro mounting strips, variable speed control, & thermal switch.



Monessen

Monessen BLOT SC

Part #	Watts	Amps	Volts	RPM	Rot	CFM	Blower	Blower Wheel	Bearing
HB-RB95	50	0.86	115	1450	CW	130	12.9"x4.3"x3.6"	65x240mm (2.6"x9.4")	Ball

Includes blower with Velcro mounting strips.



Montigo, Selkirk

Electrohome 2811-581-001, EF100, T1-RF100 (Old Rotom 1spd), 2811-581-002, EF100-2

Part #	HP	Amps	Volts	Type	Spd/RPM	Rot	CFM	Body	Frame	Bearing
T1-RF100-2	1/167	0.50	115	SP/Open	2/3000	CCW	100	2.75"	Skel	Sleeve

T1-RF100-2 blower includes mounting bracket & fan blade.



Napoleon, Continental, Wolf Steel

Continental GZ550, BCDV36NTR (Gas)

Napoleon GZ550 (Blower), GD36NTR (Gas)

Fits most Napoleon direct vent gas/propane fireplaces.

Blower Kit	Blower Only	Watts	Amps	Volts	Spd/RPM	Rot	CFM	Blower	Blower Wheel	Bearing
HB-RB58	HB-RB59	42	0.65	115	1/1463	CCW	108	10.5"x4.3"x3.6"	65x180mm (2.6"x7.1")	Ball

HB-RB58 Includes blower, mounting base, thermal switch assembly, variable speed control, mounting hardware, wiring harness - cord w/ 2-prong plug.

HB-RB59 includes blower, mounting base plate, variable speed control. Does not include mounting hardware, thermal switch or electrical assemblies.

HB-RB58
 Complete
 Blower Kit



Napoleon, Continental, Wolf Steel

Continental GZ552 - Gas - Napoleon GZ552 - Gas

Part #	Watts	Amps	Volts	Spd/RPM	Rot	CFM	Blower	Blower Wheel	Bearing
HB-RB61	42	0.65	115	1/1463	CCW	108	10.5"x4.3"x3.6"	65x180mm (2.6"x7.1")	Ball

HB-RB61 blower only.



Napoleon, Continental, Wolf Steel

EP62-1, EM3030LH186

Part #	CFM	Volts	Amps	Type	Spd/RPM	Rot	Blower	Frame	Bearing
HB-RB621	108	115	0.65	SP	1/1463	CCW	12.25"x5.25"x3.75"	Skel	Ball

Includes blower, mounting base & plate, variable speed control, cord - 3 prong plug.



Napoleon, Continental, Wolf Steel

Gas Fired Stove - GDS50

Part #	Watts	Amps	Volts	Spd/RPM	Rot	CFM	Blower	Blower Wheel	Bearing
HB-RB166	53	0.92	115	1/2400	CCW	125	12.8"x4.6"x4.3"	76x101mm (3"x4")	Ball

HB-RB166 blower only with mounting bracket with grommets.



ALL NEW!!
24 Month Warranty
on all "HB-" Products

Nordica

Nordica B150 - Blower only - Traditional 1600-2100, Rustic 1600-2100

Part #	Watts	Amps	Volts	Spd/RPM	Rot	CFM	Blower	Blower Wheel	Bearing
HB-RB166	53	0.92	115	1/2400	CCW	125	12.8"x4.6"x4.3"	76x101mm (3"x4")	Ball

Includes blower with mounting bracket with grommets.



Nordica

Part #	Watts	Amps	Volts	Spd/RPM	Rot	CFM	Blower	Blower Wheel	Bearing
HB-RB513	162	1.35	115	1/2600	CW	220	17.6"x4.25"x3"	65x330mm (2.6"x13.0")	Sleeve

HB-RB513 furnished with cooling fan OSE.



Nordica

Nordica D-100 - Blower Only - Etna-Everest 200-2500, Olympia D-100

Part #	Watts	Volts	CFM	RPM	Bearing	Impeller	Noise	Connection
T8-RF235	22	115	106	3000	Ball	Metal	50db (A)	Terminal



Nordica

Part #	Watts	Amps	Volts	Spd/RPM	Rot	CFM	Blower	Blower Wheel	Bearing
HB-RB571	45	0.38	115	1/1800	CCW	73	9.8"x3.7"x3.2"	60x180mm (2.36"x7.1")	Sleeve

HB-RB571 blower only.



Nordica

Wood Stove Blower - UE383, Fasco B24220

Part #	CFM	Amps	Volts	Spd/RPM	Rot	Body	Type	Frame	Bearing
R7-RB3	100	0.35	115	1/3220	CW	5.65"	PSC/ Open	3.3"	Ball

R7-RB3 Includes intake screen guard, 3-prong plug, round discharge - square flange.



Osburn

Osburn FD006-1600 (Inserts), 1800, 2200, 2400 (Stoves)

Part #	Watts	Amps	Volts	Spd/RPM	Rot	CFM	Blower	Blower Wheel	Bearing
HB-RB006	81	1.40	115	2/2800	CCW	125/150	12.8"x4.6"x4.3"	76x101mm (3"x4")	Ball

HB-RB006 Includes blower, housing, 3-way switch - cord with three prong plug.



Osburn

Osburn KA108

Part #	Watts	Amps	Volts	Spd/RPM	Rot	CFM	Blower	Blower Wheel	Bearing
HB-RB108	50	0.86	115	1/1450	CW	130	12.9"x4.3"x3.6"	65x240mm (2.6"x9.4")	Ball

HB-RB108 blower includes mounting base plate with grommets.



Pacific Energy Esteem

Pacific Energy 5053-947 (Kit), MNB.BLOW, ENCD.BLOW

Part #	Watts	Amps	Volts	Spd/RPM	Rot	CFM	Blower	Blower Wheel	Bearing
HB-RB50	53	0.92	115	1/2400	CW	125	12.8"x4.6"x4.3"	76x101mm (3"x4")	Ball

HB-RB50 Includes blower, mounting base w/ rubber grommets, variable speed control - cord with three prong plug.



Pacific Energy

Pacific Energy - WODC.BLOW / PACI 179B

Part #	CFM	Amps	Volts	Spd/RPM	Rot	Blower	Blower Wheel	Bearing
HB-RB179	125	0.92	115	1/2400	CW	17.5"x4.75"x4.3"	76x101mm (3"x4")	Ball

HB-RB179 Includes blower, housing, variable speed control, thermal switch, Auto./Man. operation rocker switch, cord w/ 3 prong plug.



Polaris

Polaris PG200

Part #	Watts	Amps	Volts	Spd/RPM	Rot	CFM	Blower	Blower Wheel	Bearing
HB-RB944	17	0.77	115	1/2900	CCW	105	10.3"x3.6"x3.6"	60x180mm (2.36"x7.1")	Ball

HB-RB944 blower only.

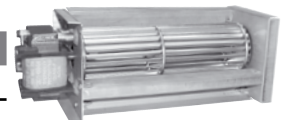

Quadra Fire

Free Standing Woodstove Blower

Part #	Watts	Amps	Volts	Spd/RPM	Rot	CFM	Blower	Blower Wheel	Bearing
HB-RB83	53	0.92	115	1/2400	CCW	125	12.8"x4.6"x4.3"	76x101mm (3"x4")	Ball

HB-RB83 - Blower housing, built in speed control - 8' cord with three prong plug



OEM Replacement



Blowers, Motors & Fan Kits

ALL NEW!!
24 Month Warranty
on all "HB-" Products

Quadra Fire

Quadra-Fire FKGAS (Stove Blower), BKGAS

Part #	Watts	Amps	Volts	Spd/RPM	CFM	Blower	Blower Wheel	Bearing
HB-RB81	81	0.92	115	1/2400	125	12.8"x4.5"x4.3"	76x101mm (3"x4")	Ball

HB-RB81 Includes blower, housing, thermal switch assembly, speed control - cord with three prong plug.



Regency

Regency 910-33/P,-142/P, I1100, I2100, I3100 (Wood Insert)

Part #	Watts	Amps	Volts	Spd/RPM	Rot	CFM	Blower	Blower Wheel	Bearing
HB-RB166	53	0.92	115	1/2400	CCW	125	12.8"x4.6"x4.3"	76x101mm (3"x4")	Ball

HB-RB166 blower, electrical leads, mounting bracket with grommets.



Regency

Regency 846-515(Kit), 910-157/P (Blower Only), F1100, F2100, F2400M, F3100 Classic (Free Standing Wood)

Part #	Watts	Amps	Volts	Spd/RPM	Rot	CFM	Blower	Blower Wheel	Bearing
HB-RB167	53	1.30	115	2/2800	CCW	125/150	12.8"x4.5"x4.3"	76x101mm (3"x4")	Ball

HB-RB167 Includes blower, electrical leads, mounting bracket with grommets.



Regency

Regency 432-917, P33, P36, P36D, P48

Part #	Watts	Amps	Volts	Spd/RPM	Rot	CFM	Blower	Blower Wheel	Bearing
HB-RB32	50	0.86	115	1/1450	CW	130	12.9"x4.3"x3.6"	65x240mm	Ball

Includes blower, mounting base, speed controller, & thermal switch assemblies.



Regency

910-331/P

Part #	Watts	Amps	Volts	Spd/RPM	Rot	CFM	Blower	Blower Wheel	Bearing
HB-RB64	50	0.86	115	1/1450	CW	130	12.9"x4.3"x3.6"	65x240mm (2.6"x9.4")	Ball

Blower only.

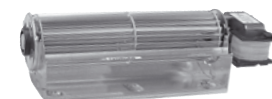

RSF

RSF - FO-FDHB5-N - Mdl. Onyx/Opel/Delta

Part #	Blower Only	CFM	Amps	Volts	RPM	Blower	Blower Wheel	Bearing
HB-RB53	HB-RB53B	225	1.30	115	1450	25.75"x4.3"x3.6"	65x240mm (x2)	Ball



S.B.I

General Replacement Wood Stove Blower

Part #	HP	Volts	Amps	Type	Spd/RPM	Rot	CFM	Body	Frame	Bearing
R7-RB33	1/25	120	0.60	ECM/Open	1/2800	CW	73	6.6"	3.3"	Ball

HB-RB33 Includes intake screen guard, built-in variable speed control, 3-prong plug, round discharge - square flange.



Security

Security UZY4 - Fan kit (Wood Fireplace)

Blower Kit	Blw. Only	Watts	Amps	Volts	RPM	Rot	CFM	Blower	Blw. Wheel	Bearing
HB-RB267	HB-RB67	35	0.75	115	1/1800	CCW	80	12.9"x4.3"x3.6"	65x120mm	Ball

HB-RB267 Includes two blowers, instructions, mounting bases, thermal switch assembly with mounting magnets, wiring harness - cord with three prong plug. HB-RB67 Includes one blower & mounting base plate with grommets.



Security

Security UZY Old BIS1 & BIS2

Part #	Watts	Volts	CFM	RPM	Bearing	Impeller	Noise	Connection
T8-RF235	22	115	106	3000	Ball	Metal	50db (A)	Terminal



Selkirk

45mm Blowers & Kits

Blower Kit	Blower Only	Watts	Amps	Volts	RPM	Rot	CFM	Blower	Blower Wheel	Bearing
HB-RB89	HB-RB85	23	0.46	115	2050	CW	75	10.4"x3.25"x2.8"	45x180mm (1.8"x7.1")	Sleeve
HB-RB88	HB-RB87	35	0.60	115	1900	CW	110	15.4"x3.25"x2.8"	45x300mm (1.8"x11.8")	Sleeve

HB-RB89 & HB-RB88 Include blower, mounting base, thermal switch assembly, variable speed control & cord with three prong plug.

HB-RB85 & HB-RB87 Include blower & cord with three prong plug.

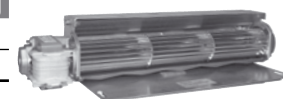

Skytech

FK-180

Part #	CFM	Amps	Volts	Spd/RPM	Rot	Blower	Blower Wheel	Bearing
HB-RB861	180	1.48	115	1/2900	CCW	12.8"x4.6"x4.3"	76x101mm (3"x4")	Ball

Includes blower with magnetic mounting, thermal switch, variable speed control, cord with two prong plug.



ALL NEW!!
24 Month Warranty
on all "HB-" Products

Valor

HB-RB555 - 555CFK Models 530, RF24, MF28
 HB-RB755 - 755CFK Models 534, 535, 650, 738 (BV Only), 739

Blower Kit	CFM	Amps	Volts	RPM	Rot	Body	Blower Wheel	Bearing
HB-RB555	67	0.46	115	1/2200	CW	7.80	45x180mm (1.8"x7.1")	Sleeve
HB-RB755	125	0.92	115	1/2400	CCW	12.80	76x101mm (3"x4")	Ball

Kits include blower, variable speed control, & thermal switch.

HB-RB555

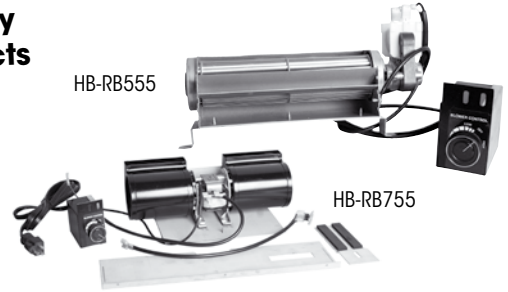

HB-RB755



Vermont Casting, Dutchwest, Stardance, CFM

Dutchwest FK26 (#2465 Direct Vent Gas Stove & #2467 Natural Vent Gas Stoves)
 Stardance FK26 (SNV30 Natural Vent Gas Stove)

Part #	Watts	Amps	Volts	Spd/RPM	Rot	CFM	Blower	Blower Wheel	Bearing
HB-RB27	53	0.92	115	1/2400	CCW	125	12.8"x4.6"x4.3"	76x101mm (3"x4")	Ball

HB-RB27 Includes blower, mounting base & variable speed control assembly - cord with three prong plug.

LEGAL NOTICE

Rotom is a registered trademark of Alltemp Products Company Limited (Alltemp)

It is important to note that Alltemp is not affiliated with any of the original equipment manufacturers or their brands which may be referred to herein. All brand names or trademarks used herein are the property of their respective owners and all original equipment manufacturers' names, numbers, symbols and descriptions are for cross reference purposes only. It is not implied that any part referred to herein is the product of any original equipment manufacturer, nor any of its associated brands. TRADEMARK DISCLAIMER - Product names, logos, brands, and other trademarks featured within are the property of their respective trademark holders. These trademark holders are not affiliated with Alltemp, our products or our website. No association between Alltemp and any trademark holder is expressed or implied. Names, numbers, symbols and descriptions are for cross reference purposes only.

UNIVERSAL

Double Centrifugal Blower Kit

- Fits many OEM gas & wood fireplaces!
- All components feature magnets for easy installation!
- Kit includes blower, pre-assembled thermal sensor and variable speed control assembly complete with cord and three prong plug!

MAGNETIC MOUNTING!

Blower, Thermal Sensor & Speed Control



Blower Kit	Blower Only	Watts	Amps	Volts	Spd/RPM	Rot	CFM	Blower	Blower Wheel	Bearing
HB-RB38	HB-RB38B	53	0.92	115	1/2400	CW	125	12.8"x4.7"x4.3"	76x101mm (3"x4")	Ball

UNIVERSAL

Tangential Blower Kit

- Fits many OEM gas & wood fireplaces!
- All components feature magnets for easy installation!
- Kit includes blower, pre-assembled thermal sensor and variable speed control assembly complete with cord and three prong plug!



Part #	Blower Only	Watts	Amps	Volts	Spd/RPM	Rot	CFM	Blower	Blower Wheel	Bearing
HB-RB39	HB-RB39B	50	0.86	115	1/1450	CW	130	12.9"x4.3"x3.6"	65x240mm (2.6"x9.4")	Ball

Pellet Stove Gear Auger Motors

- 115 Volt • Sleeve Bearing • Single Speed • Shaded Pole • CCW Rotation

Part #	Amps	RPM	Body	Shaft	Features	Cross Reference
HM-RGM450	0.25	1.0	3.2"	1.1"x3/8"	Spade terminals, Inc.'s 6 mtn. bolts 14 Watts Out	Enviro EF001
HM-RGM451	0.19	1.0	3.0"	1"x3/8"	Spade terminals, Inc.'s 6 mtn. bolts 1.5 Watts Out	Lennox Hearth 6216, Fasco V08038AA09
HM-RGM453	0.19	1.0	3.2"	1.1"x3/8"	Centered spade terminals, Inc.'s 6 mtn. bolts 11 Watts Out	
HM-RGM452	1.26	2.0	3.0"	1"x3/8"	Bare wire leads, Inc.'s 6 mtn. bolts	Canadian Comfort Industries, Fasco V07926AAD9
HM-RGM454	0.73	4.0	3.2"	1.1"x3/8"	Spade terminals, Inc.'s 6 mtn. bolts 35 Watts Out	
HM-RGM651	1.00	7.0	3.25"	1"x1/2"	Bare wire leads, Inc.'s 4 mtn. bolts & 2" dia. fan blade, 50 Watt	EMC6216, Fasco V07959ABD9

Replacements For:
 Avalon, Austroflamm, Breckwell, Enviro, Earth Stove, Fasco, Lennox, Merkle-Korff Ind., National Steel Crafters, Pellet Master, Travis Ind., Whitfield (Quest), Traditions & Profile Series Stoves.

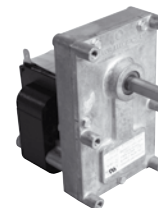

HM-RGM451 illustrated

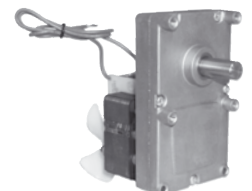

HM-RGM651 illustrated

Pellet & Box Frame Motors



ALL NEW!!
24 Month Warranty
on all "HB-" Products

Pellet Stove Blower Motors

Whitfield - Quest

Whitfield - Quest 12026011, 13656011, Breckwell, Travis (Avalon & Lopi) Quadra-Fire, Fasco 7021-9129

Part #	HP	Volts	Amps	Type	Spd/RPM	Rot	Body	Frame	Bearing
HB-RBM120	1/14	115	0.60	SP/Open	1/3000	CCW	5.25"	3.3"	Sleeve

HB-RBM120 Includes 6 mounting nuts, gasket, fan blade & plug.
 Mounting - 5.75" Diameter, 5.5" Mounting Centers



Whitfield - Convection Blower

Whitfield 12126109, Fasco 7021-7786

Part #	HP	Volts	Amps	Type	Spd/RPM	Rot	Body	Frame	Bearing
HB-RBM121	1/35	115	1.50	SP/Open	1/3000	CW	7.3"	3.3"	Sleeve

HB-RBM121 Square discharge, square flange & plug.



Lennox - Earth Pellet Stove Blower

Lennox 15007 (Model), 8253710702 (Blower)

Part #	HP	Volts	Amps	CFM	Type	Spd/RPM	Rot	Body	Frame	Bearing
HB-RB150	1/35	115	1.00	155	SP/Open	1/1500	CW	7.4"	3.3"	Sleeve

HB-RB150 Square discharge, square flange, 2 bare wire leads & 1 plug.



Box Frame Blowers

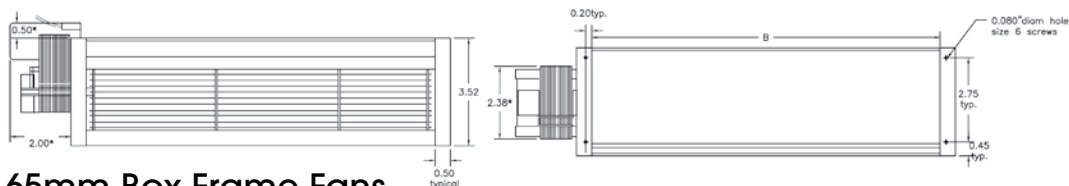

HB-RB944 illustrated

65mm Box Frame Fans

Part #	Watts	Volts	Amps	Spd/RPM	Rot	CFM	Bearing	Body	Wheel	B
HB-RB944	17	115	0.77	1/2900	CCW	105	Ball	10.3"×3.6"×3.6"	2.25"×7.13"	7.31"
HB-RB939	29	115	0.62	1/2800	CW	180	Ball	15.5"×3.6"×3.6"	2.25"×12.25"	12.46"
HB-RB949	29	115	0.97	1/2900	CCW	180	Ball	15.5"×3.6"×3.6"	2.25"×12.25"	12.46"
HB-RB950	29	240	0.30	1/2900	CCW	180	Ball	15.5"×3.6"×3.6"	2.25"×12.25"	12.46"

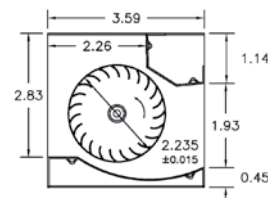

Box Frame Blowers - Double



HB-RB96 illustrated

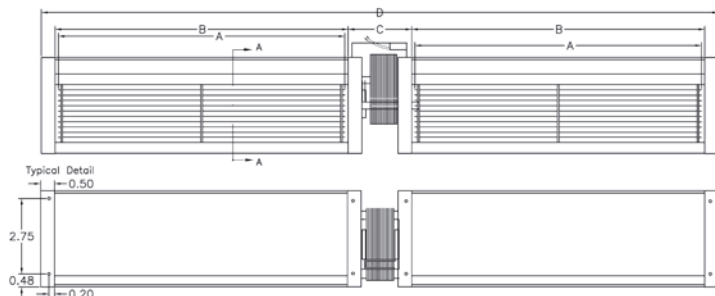
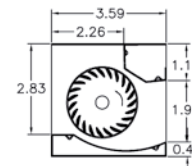

Double Tangential Fan

Sil-Flo: Marcot Baseboard Heater, Lau T221-18 (HB-RB221)

Part #	Watts	Volts	Amps	Spd/RPM	Rot	CFM	Bearing	Body	Frame	Wheel	B	C	D
HB-RB96	58	115	1.50	1/2900	CW	360	Ball	28.6"×3.6"×3.6"	Skel	2.25"×12.25"	12.46"	3.02"	28.61"

Rotation Opposite Shaft End / Double Shaft Lead End

ALL NEW!!
24 Month Warranty
on all "HB-" Products

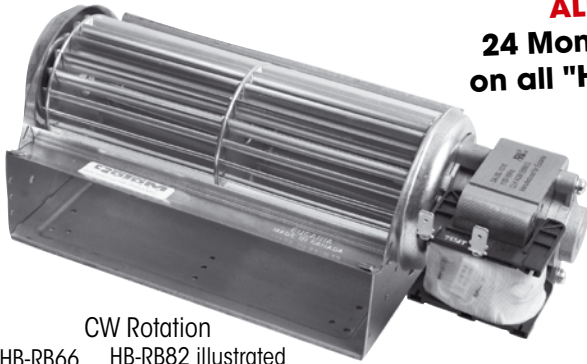

CW Rotation

- HB-RB66 HB-RB82 illustrated
- HB-RB64 HB-RB69
- HB-RB611 HB-RB41
- HB-RB45

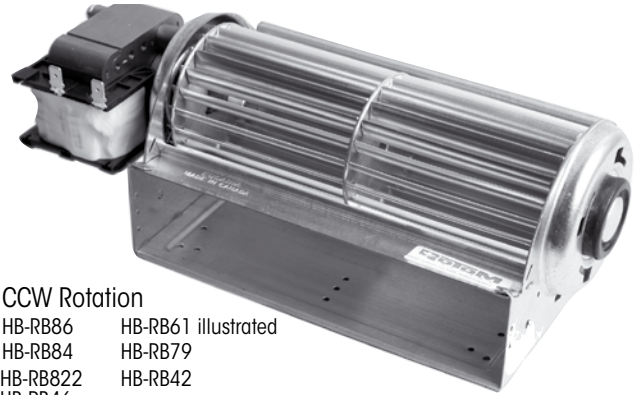

CCW Rotation

- HB-RB86 HB-RB61 illustrated
- HB-RB84 HB-RB79
- HB-RB822 HB-RB42
- HB-RB46



Telescopic Spout That Reaches Everywhere!

The Finest All-Purpose Industrial Oil

10-ZS75

* 118 ml Bottle

* 12/ctn

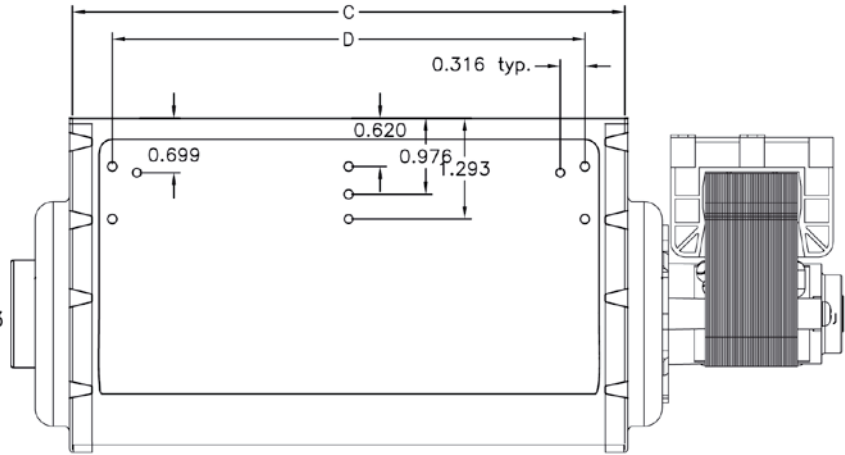
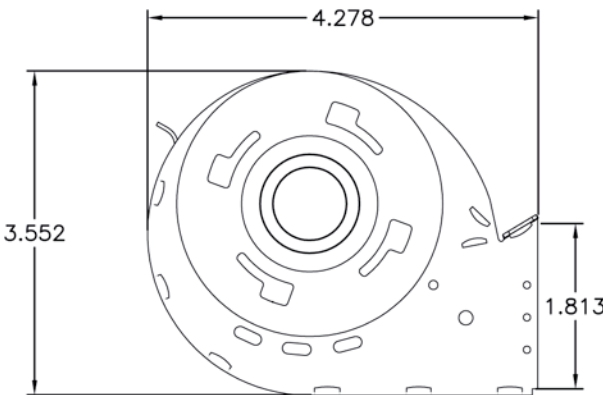
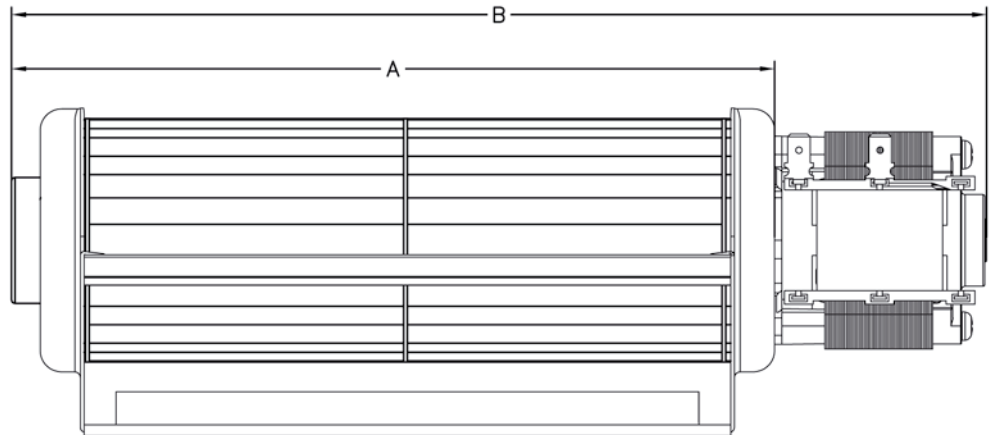

65mm Tangential Fans - Standard Duty

Part #		Watts	Volts	Amps	Spd/RPM	CFM	Bearing	Body	Wheel	Dimensions			
CW Rot	CCW Rot									A	B	C	D
HB-RB66	HB-RB86	35	115	0.75	1/1800	80	Ball	8.0"×4.3"×3.6"	65×120mm (2.6"×4.7")	6.00"	8.32"	4.72"	3.70"
HB-RB82	HB-RB822	42	115	0.75	1/1600	110	Ball	10.5"×4.3"×3.6"	65×180mm (2.6"×7.1")	8.36"	10.69"	7.09"	6.06"
HB-RB611	HB-RB61	42	115	0.75	1/2400	160	Ball	10.5"×4.3"×3.6"	65×180mm (2.6"×7.1")	8.36"	10.69"	7.09"	6.06"
HB-RB64	HB-RB84	50	115	0.86	1/1450	130	Ball	12.9"×4.3"×3.6"	65×240mm (2.6"×9.4")	10.72"	13.05"	9.45"	8.43"
HB-RB69	HB-RB79	62	115	1.10	1/1200	150	Ball	15.7"×4.3"×3.6"	65×300mm (2.6"×11.8")	13.09"	15.72"	11.81"	10.79"

Motor on right side of blower Motor on left side of blower

65mm Tangential Fans - Heavy Duty - Ball Bearing Motor & End Bearing

Part #		Watts	Volts	Amps	RPM	CFM	Bearing	Body	Wheel	Dimensions			
CW Rot	CCW Rot									A	B	C	D
HB-RB41	HB-RB42	54	115	0.80	2100	160	Ball	10"×4.3"×3.5"	65×180mm (2.6"×7.1")	8.36"	10.0"	7.08"	6.09"
HB-RB45	HB-RB46	54	115	0.80	1500	140	Ball	12.6"×4.3"×3.5"	65×240mm (2.6"×9.4")	10.12"	12.6"	9.45"	8.43"

80mm x 80mm x 38mm (3.15" x 3.15" x 1.5")

• Mounting Centres 71.5mm (2.82")

Part #	Watts	Volts	CFM	RPM	Bearing	Impeller	Noise	Connection	Weight
T8-RF200	10	115	32	3100	Sleeve	Metal	34db (A)	Wire Leads	420g
T8-RF201*	9	115	21	2000	Sleeve	Metal	26db (A)	Wire Leads	420g
T8-RF202*	10	230	32	3100	Ball	Metal	34db (A)	Wire Leads	420g

120mm x 120mm x 38mm (4.72" x 4.72" x 1.5")

• Mounting Centres 105mm (4.13")

Part #	Watts	Volts	CFM	RPM	Bearing	Impeller	Noise	Connection	Weight
T8-RF205	22	115	106	3000	Sleeve	Metal	50db (A)	Terminal	600g
T8-RF210	22	115	106	3000	Ball	Metal	50db (A)	Terminal	600g
T8-RF225	22	115	106	3000	Ball	Metal	50db (A)	Wire Leads	600g
T8-RF215	21	230	106	3000	Sleeve	Metal	50db (A)	Terminal	600g
T8-RF220	21	230	106	3000	Ball	Metal	50db (A)	Terminal	600g

119mm x 119mm x 38mm (4.69" x 4.69" x 1.5")

• Mounting Centres 105mm (4.13")

Part #	Watts	Volts	CFM	RPM	Bearing	Impeller	Noise	Connection	Weight
T8-RF230	12	115	106	3100	Sleeve	Plastic	46db (A)	Terminal	530g
T8-RF235	12	115	106	3100	Ball	Plastic	46db (A)	Terminal	530g
T8-RF236*	15	230	106	3100	Sleeve	Plastic	46db (A)	Terminal	530g
T8-RF237*	15	230	106	3100	Ball	Plastic	46db (A)	Terminal	530g

150mm x 150mm x 55mm (5.9" x 5.9" x 2.2")

• Mounting Centres 162mm (6.38")

Part #	Watts	Volts	CFM	RPM	Bearing	Impeller	Noise	Connection	Weight
T8-RF240	42	115	230	3400	Ball	Plastic	53db (A)	Wire Leads	1kg
T8-RF245	40	230	230	3400	Ball	Plastic	53db (A)	Wire Leads	1kg

150mm x 172mm x 38mm (5.9" x 6.7" x 1.5")

• Mounting Centres 162mm (6.38")

Part #	Watts	Volts	CFM	RPM	Bearing	Impeller	Noise	Connection	Weight
T8-RF247*	28	115	212	3400	Ball	Plastic	58db (A)	Terminal	720g
T8-RF248*	26	230	212	3400	Ball	Plastic	58db (A)	Terminal	720g

180mm x 180mm x 90mm (7.1" x 7.1" x 3.5")

• Mounting Centres 152.7mm (6.01")

Part #	Watts	Volts	CFM	RPM	Bearing	Impeller	Noise	Connection	Weight
T8-RF249*	72	115	460	3400	Ball	Plastic	59db (A)	Screw	2.2kg

254mm x 254mm x 89mm (10" x 10" x 3.5")

• Mounting Centres 247mm (9.72")

Part #	Watts	Volts	CFM	RPM	Bearing	Impeller	Noise	Connection	Weight
T8-RF250	35	115	547	1650	Ball	Plastic	55db (A)	Terminal	1.9kg
T8-RF255	33	230	547	1650	Ball	Plastic	55db (A)	Terminal	1.9kg

Axial Fan Features:

- Die-cast Aluminum Housing
- Shaded Pole Motor
- Impedance Protection
- CSA & UL Approved.
- Operating Temp. Range -10°C to 70°C
- Metal or Plastic Impellers
- Sleeve or Ball Bearings



T8-RF210 illustrated



T8-RF200 illustrated



T8-RF230 illustrated



T8-RF245 illustrated



T8-RF250 illustrated

Metal Fan Guards

Mounting: Screw Holes

Part #	Size
T8-CFG-60M	66mm
T8-CFG-80M	80mm
T8-CFG-92M	92mm
T8-CFG-120M	120mm
T8-CFG-150M	150mm
T8-CFG-254M	254mm

Plastic Fan Guards

Mounting: Plastic Tabs

Part #	Size
T8-CFG-80P	80mm
T8-CFG-120P	120mm

Note: T8-CFG-80M, 120M, 150M are also available in black.*



T8-CFC-T24 illustrated

Axial AC Power Cords

Bare Wire - 2 Pin molded connection to bare wire leads.

Plug - 2 Pin molded connection to 2 prong plug.

Bare Wire	Description	Plug
T8-CFC-T24	60.96cm (24") Cord	T8-CFC-T24P
-	121.92cm (48") Cord	T8-CFC-T48P
T8-CFC-T72	182.88cm (72") Cord	T8-CFC-T72P



R7-RB440



R7-RB55

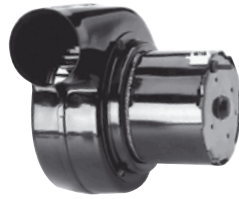

R7-RB663



R7-RB662



R7-RB661



R7-RB60

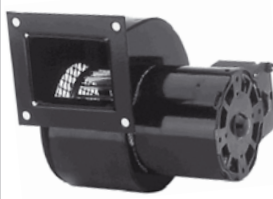

R7-RB70



R7-RB33



R7-RB665



R7-RB885



R7-RB90



R7-RB991



R7-RB4



R7-RB3



R7-RB2

Part #	CFM	Spd/RPM	Volts	Amps	Rot	Type	Encl	Bearing	Cross
R7-RB440	50	1/3080	115	0.25	CW	PSC	Open	Ball	Grainger 1TDN7, 4C440
R7-RB55	55	1/1550	115	0.25	CW	SP	Open	Sleeve	AO Smith 12
R7-RB663	60	1/3000	115	0.60	CCW	SP	T.E.	Sleeve	AO Smith 9444
R7-RB662	60	1/3000	208/240	0.30	CCW	SP	Open	Sleeve	AO SMITH 9443, FASCO 50747-D230, GRAINGER 2C014
R7-RB661	60	1/3000	115	0.50	CCW	SP	Open	Sleeve	AO SMITH 9461, FASCO 50747-D500
R7-RB60	60	1/3200	115	0.80	CW	SP	Open	Sleeve	AO SMITH 9470, FASCO 50747-D401
R7-RB70	70	1/3000	115	0.50	CCW	SP	Open	Sleeve	AO Smith 989
R7-RB33	73	1/2800	115	0.60	CW	ECM	Open	Ball	Newmac 204001 EB3 w/ Variable Spd Switch
R7-RB665	75	1/3020	115	0.45	CCW	PSC	Open	Ball	AO SMITH 9462, FASCO 50748-D500, GRAINGER 4C443
R7-RB885	85	2/2800	115	0.65	CW	SP	Open	Sleeve	AO SMITH 414
R7-RB90	90	1/3000	115	1.00	CW	SP	Open	Sleeve	AO SMITH 13
R7-RB991	90	1/3000	115	1.00	CW	SP	Open	Sleeve	AO SMITH 383
R7-RB4	100	1/3220	115	0.34	CW	PSC	T.E.	Ball	Franklin 76012, 80042, Electrohome EB4
R7-RB3	100	1/3220	115	0.34	CW	PSC	Open	Ball	Fasco B24220
R7-RB2	100	1/1550	115	0.47	CW	SP	T.E.	Sleeve	Franklin 76002, 80978, Electrohome EB2



Part #	CFM	Spd/RPM	Volts	Amps	Rot	Type	Encl	Bearing	Cross
R7-RB54	100	1/3450	115	0.43	CW	PSC	T.E.	Ball	Easy Radiant
R7-RB120	120	1/3100	115	0.80	CW	SP	Open	Sleeve	AO Smith 9445
R7-RB141	140	1/3000	115	1.00	CCW	SP	Open	Sleeve	AO Smith 9492, Fasco 50752-D500, GRAINGER 4C442
R7-RB142	140	1/3000	208/240	0.50	CCW	SP	Open	Sleeve	AO Smith 9493, Fasco 50752-D230, Grainger 2C915
R7-RB446	146	1/3120	115	0.75	CCW	PSC	Open	Ball	Grainger 4C446, 1TDP7, Fasco 7021-3469, A166
R7-RB155	148	1/2480	115	0.75	CCW	PSC	T.E.	Ball	Grainger 1TDR6, 4C006, Fasco 7021-4933
R7-RB151	150	1/3000	115	1.10	CCW	SP	Open	Sleeve	AO Smith 9483
R7-RB160	160	1/1595	115	1.20	CCW	SP	Open	Sleeve	AO Smith 458
R7-RB165	165	1/3550	115	0.65	CCW	PSC	Open	Ball	-
R7-RB180	180	3/1500	115	2.00	CCW	SP	Open	Sleeve	AO Smith 9471, Fasco B47120, Grainger 4C754
R7-RB1	200	1/2700	115	1.10	CW	SP	Open	Sleeve	Franklin 80748, 80981, Electrohome EB1
R7-RB312	222	1/2750	115	0.60	CCW	PSC	Open	Ball	Grainger 1TDU8, 4C826, Fasco A212, 70219025
R7-RB245	245	1/1550	115	1.50	CCW	SP	Open	Sleeve	AMU45, Airdex
R7-RB265	265	1/1640	115	0.77	CCW	PSC	Open	Ball	Franklin 80224, U.E.459, Fasco B45227
R7-RB266	265	1/1650	230	1.90	CCW	SP	Open	Sleeve	AO Smith 9411, Fasco B45227-2, Grainger 4C869

Flange Mounting Dimensions Available on Page 21 & 22

Rotation Opposite Shaft End / Double Shaft Lead End



R7-RB447



R7-RB938



R7-RB320



R7-RB326

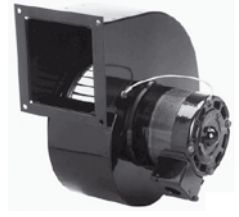

R7-RB350



R7-RB428



R7-RB462



R7-RB465



R7-RB495



R7-RB500



R7-RB445



R7-RB760



R7-RB965



R7-RB1000

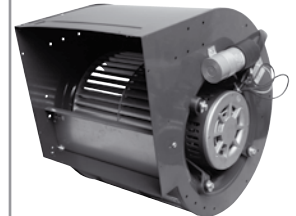

R7-RB1600

Part #	CFM	Spd/RPM	Volts	Amps	Rot	Type	Encl	Bearing	Cross
R7-RB447	273	1/1640	115	0.77	CCW	PSC	Open	Ball	Grainger 4C447, 1TDR3
R7-RB938	287	1/3280	115	1.30	CCW	PSC	Open	Ball	ProFab 814320, Aspen, Empyre, Fasco 70625938
R7-RB320	320	1/1500	115	1.30	CW	SP	Open	Sleeve	AO Smith 9486, Fasco 50756-D500
R7-RB326	326	1/1600	115	1.10	CCW	PSC	Open	Ball	AO Smith 9467, Grainger 4C943
R7-RB350	350	2/1570	115	3.00	CCW	SP	Open	Sleeve	AO Smith 9466, Grainger 4C444
R7-RB428	428/ 293	2/1500 /1085	115	1.1/ 0.85	CW	PSC	Open	Ball	GRAINGER 1TDT6, 4C565
R7-RB462	460	1/1550	230	1.80	CW	SP	Open	Sleeve	AO Smith 9412, Grainger 5C507
R7-RB465	465	1/1560	115	1.30	CW	PSC	Open	Ball	Franklin 80546, U.E.460, Fasco B45267, Grainger 4C448
R7-RB495	495	1/1570	115	3.80	CCW	SP	Open	Sleeve	AO Smith 9465
R7-RB500	500	2/1550	115	3.50	CCW	SP	Open	Sleeve	AO Smith 9491, Fasco 50769-D500
R7-RB445	549	1/1430	115	2.20	CCW	PSC	Open	Ball	Grainger 1TDT2, 4C445, 4YJ32
R7-RB760	797	2/1350	115	3.30	CW	PSC	Open	Ball	AO Smith 9459, Grainger 5C508
R7-RB965	965	1/1080	115	3.50	CCW	PSC	Open	Ball	Grainger 1TDT5
R7-RB1000	1000	2/1100	115/230	4.00	CCW	PSC	Open	Sleeve	AO Smith 9477, Fasco A1000
R7-RB1600	1638	4/1085	115	6.90	CCW	PSC	Open	Ball	Grainger 1XJX9

In-Line Air Duct Booster Fans



In-Line Air Duct Booster Fans

Air Duct Booster

Designed to be installed at any angle in the branch duct of under-ventilated rooms to increase either hot or cool air flow supply. One year limited warranty.



Control Options

- Manual Control**
 - 115V Source - continuous operation.
 - 115V Switch - manual ON/OFF ctrl.
- Automatic Control**
 - Wire to furnace fan.
 - Wire to fan switch.
 - Wire to a sail switch.
 - Wire to a pressure switch.
 - Wire to thermostat.

Standard Air Duct Boosters



Part #		Description	Max Boosted Free Air		Watts	Amps	dBA	Blade	Housing Length
No Cord	Cord		CFM	CFM					
T9-DB100C	-	6" - 8" Universal Round	250	160	30	0.35	50	Polycarbonate	4"x11"
T9-DB6-2CR	-	6" Rnd Double Crimp	250	160	30	0.35	50	Polycarbonate	8"
-	T9-DB204C	4" Round	80	40	30	0.30	52	Polycarbonate	6"
-	T9-DB205C	5" Round	225	140	30	0.35	51	Polycarbonate	6"
-	T9-DB206C	6" Round	250	160	30	0.35	50	Polycarbonate	6"
-	T9-DB208C	8" Round	500	210	60	0.75	54	Polycarbonate	8"
-	T9-DB210C	10" Round	650	300	120	1.50	55	Aluminium	8"
-	T9-DB212C	12" Round	800	650	120	1.50	55	Aluminium	8"



T9-DB6 illustrated



T9-DB205-CRD illustrated

Part #	Diameter	CFM	Watts	Order Mult
625-AF6	6"	240	37	4
625-AF8	8"	420	37	4
625-AF10	10"	650	35	4
625-AF12	12"	975	65	2
625-AF14	14"	1350	65	1



Two Speed Air Duct Boosters



Part #	Description	Max Boosted CFM	Free Air CFM	Watts	Amps	dBA	Blade
T9-DB306E	6" Round 2 Speed	200/300	160/180	30	0.35	50/52	Polycarbonate
T9-DB8-2	8" Round 2 Speed	500/600	210/250	60	0.85	50/55	Polycarbonate
T9-DB10-2	10" Round 2 Speed	650/900	300/460	135	1.70	56/59	Aluminium

T9-DB5-2 illustrated



4-Pole Duct Boosters

Designed for larger ducts requiring commercial grade power and performance.



Part #	Description	Max Boosted CFM	Free Air CFM	Watts	Amps	dBA	Blade
T9-DB412E	12" Round	1160	700	120	1.00	61	Aluminium
T9-DB144	14" Round	1580	900	120	1.00	61	Aluminium
T9-DB416P	16" Round	1760	1100	120	1.00	54	Aluminium

4-Pole Duct Booster illustrated



Motorized Duct Dampers

Motorized Dampers



Normally Open Part #	Normally Closed Part #	Duct Dia.	Weight
T9-MD6-NO	T9-MD6-NC	6"	3.5
T9-MD8-NO	T9-MD8-NC	8"	4.0
T9-MD10-NO	T9-MD10-NC	10"	5.0
T9-MD12-NO	T9-MD12-NC	12"	6.0

Features

- Available in normally open or normally closed 5", 6", 7", 8", 10" and 12" duct diameters.
- 8" Housing lengths.
- 24VAC, 0.25 amps.
- 100% Shut off available.
- 3 Year limited warranty.

Zone Control

T9-MD6 illustrated



ThruWall Room To Room Fans

The T9-TW8-2 and T9-TW208 ThruWall™ fans easily install in an interior wall to move heated or cooled air from one adjoining room to another, providing year round comfort.

- Ultra quiet operation.
- White polymeric grills can be painted to match decor.
- Telescoping housing (Galvanized steel) installs in frame walls from 3½" to 6½" thick.
- 10' Grounded cord(T9-TW8-2)
- Bare Wire Leads (T9-Tw208)



T9-TW8-2



T9-TW208

Direction Airflow!
360° Rotating Grill

ThruWall Fans

Part #	Features	Description	Volts	Amps	CFM	dBa	Weight
T9-TW8-2	• 3 Position, 2 Speed switch	Grill 9.75" Housing 7 5/8" dia.	115	0.75	160 CFM low spd. 200 CFM high spd.	High: 55 Low: 49	5.0 lbs.
T9-TW208	• Built-in solid state speed control allows for fan speed & sound level control. • 360° Rotating grill allows airflow direction to be changed.	Front: 12.5"x10" Back: 9.75" dia. Housing: 8" dia.	115	0.75	40 CFM low spd. 90 CFM high spd.	High: 55 Low: 49	5.0 lbs.

60 Hz., Thermally protected, Class B insulation.

Door Frame Fan

Entreeair® Door Frame Fan

The T9-DF100 is a safe, efficient and effective way to gently circulate warm or cool air from room to room.

- Quiet operation.
- Simple installation.
- In-line ON/OFF power switch.
- 10' Cord.
- Patented design.

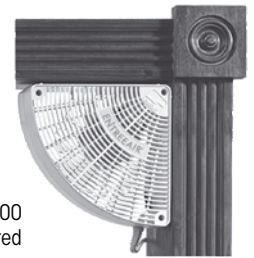

T9-DF100
illustrated



Part #	Description	Volts	Amps	CFM	Weight
T9-DF100	7" Grill diameter.	115	0.35	100	2.0 lbs.

60 Hz., Thermally protected, Class B insulation.

Register Air Boosters

Register Boosters™ increase airflow to under performing registers improving comfort to rooms that are too hot or too cold.

- Saves energy and money.
- Engineered for maximum airflow.
- Low voltage – safe for children and pets.
- Works automatically with forced air systems.
- 12 month limited warranty.



T9-EQ2
Manual - On/Off
Auto - Heat/Cool
(Adjustable thermostat & sensitivity differential)



Equalizer® Register Air Booster

Part #	Dimensions	Volts	Amps	Weight
T9-EQ2	12" x 6-¼" x 3¼"	115	0.35	2.25 lbs.

60 Hz., Thermally protected, Class B insulation.

Flush Fit™ Register Air Booster

Part #	CFM	Watts	Volts	Colour
T9-HC500-W	85	15	115	White
T9-HC500-B	85	15	115	Brown

Fits 4"x10" Floor and wall openings
Available (not included) adapter plate for: 4"x12", 6"x10" & 6"x12"

Adapter plate
White - T9-HC5PL1-W
Brown - T9-HC5PL1-B



Duct Thermostat

Plug-In Duct Stat

The T9-DS45110 duct stat simplifies installation of in-line duct booster fans by eliminating electrical connections at the furnace.

- Economical and reliable automatic on/off control for in-line duct booster fans.
- Mounts on duct or wall to control ambient room temperature.
- Adjustable temperature range: 45° F (7° C) to 110° F (43° C) and differential.
- 6' Grounded cord.
- Year round use, ON/ OFF, AUTO heating and AUTO cooling.
- Controls various devices, including alarms, heat lamps, lights, louvers, etc.



T9-DS45110
illustrated



Plug-In Switch - Thermostatically Controlled

Part #	Description	Volts	Dimensions	Weight
T9-DS45110	5 Amp maximum load (replaceable 5A fuse).	115	5.50" x 3.25" x 2.25"	1.25 lbs.

60 Hz.

Rotation Opposite Shaft End / Double Shaft Lead End

Speed Controls & Switches



Speed Controls



Complete with control, knob, face plate & hardware.



HB-RB38-1
Speed Control Assembly



HB-RB168-1
Variable Speed Control

Motor Speed Controls

Complete with control, knob, face plate & hardware.

Part #	Volts	Amps	Description
92-A8301	120	2.5	Std. Ctrl Kit
92-A8301-1	120	2.5	No Face Plate
92-A8303	120	5	Std. Ctrl Kit
92-A8303-1	120	5	No Face Plate
92-A8305	120	10	W/ Heat Sink
92-A8306	120	15	W/ Heat Sink

Part #	Amps	Description
HB-RB38-1	3.0	Magnetically Mounted Speed Control & Thermal Switch Assembly
HB-RB168-1	3.0	Variable Speed Control

Rocker Switches - Snap-in Mount

Type	Part #	Colour	Function	Amps	¼"Spades	Fig.
Mini	29-159-1	Black	2 - On / Off	15	3	1
	29-159-3	Black	2 - On / Off	10	2	2
	29-159-5	Black	3 - On / Off / On	10	3	2



Fig.3



Fig. 1



Fig. 2

Limit Switches

Limit Switch Nomenclature

L	Limit - Open on rise
S	Switch
2	Number of terminals
110	Opening temperature

Limit Switches

- 25 Amps, 240 Volt
- 2 Terminal

Part #	Part #
19-LS2-120	19-LS2-190
19-LS2-135	19-LS2-200
19-LS2-140	19-LS2-200F
19-LS2-145	19-LS2-240
19-LS2-150	19-LS2-250
19-LS2-160	19-LS2-275
19-LS2-165	19-LS2-290
19-LS2-180	19-LS2-320

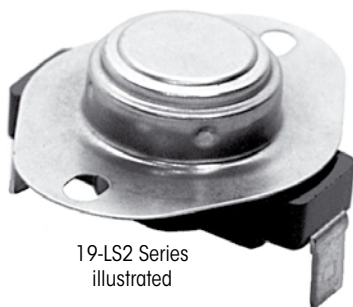

19-LS2 Series
illustrated

Fan Switches

Fan Switch Nomenclature

F	Fan - Close on rise
S	Switch
2	Number of terminals
110	Closing temperature

Two Terminal Fan Switches
• 3/4" standard discs.

Part #	Closing Temp.
19-SF2-115*	43°C (110°F)
19-FS2-110	43°C (110°F)
19-FS2-120	49°C (120°F)
19-FS2-130	54°C (130°F)
19-FS2-160	71°C (160°F)
19-FS2-200	93°C (200°F)

* 1/2" disc



19-FS2-110
illustrated

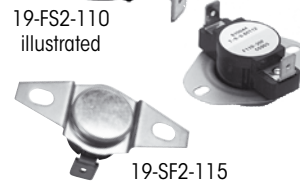

19-SF2-115

Fireplace Kit Accessories

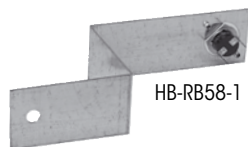

HB-RB58-1



HB-RB168-2



HB-RB67-3



HB-RB67-5



HB-RB68-1



HB-RB67-1 (One Blower)
HB-RB67-2 (Two Blower)

Thermal Switch Assemblies

Part #	Description
HB-RB58-1	Thermal Switch Assembly
HB-RB168-2	Thermal Switch Assembly
HB-RB67-3	Magnetic Thermal Switch Assembly
HB-RB67-5	Thermal Switch Assembly & Wiring
HB-RB68-1	Thermal Switch Assembly
HB-RB67-1	Magnetic Thermal Switch & Wiring Harness Assembly For 1 or 2 Blowers
HB-RB67-2	Magnetic Thermal Switch & Wiring Harness Assembly For 1 or 2 Blowers

Note : All switches are 43°C (110°F)

Forged Gas Ball Valves

- Brass or plated outdoor.
- Yellow lever handle.
- 600 WOG full port.



Brass (Indoor) or
Plated (Outdoor)
Applications

Brass Indoor	Plated Outdoor	Description	Case Qty
06-FGV38	06-FGV38P	3/8" FNPT x 3/8" FNPT	5
06-FGV12	06-FGV12P	1/2" FNPT x 1/2" FNPT	5
06-FGV34	06-FGV34P	3/4" FNPT x 3/4" FNPT	5
06-FGV1	06-FGV1P	1" FNPT x 1" FNPT	2
-	06-FGV114P	1 1/4" FNPT x 1 1/4" FNPT	2
06-FGV112	06-FGV112P	1 1/2" FNPT x 1 1/2" FNPT	2
-	06-FGV2P	2" FNPT x 2" FNPT	2

Appliance Forged Gas Ball Valves

- Brass ball valves.
- Red wing handle.
- 600 WOG.

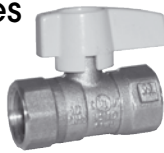

Part #	Description	Case Qty
06-GWH12	1/2" FNPT x 1/2" FNPT, 3/8" port	10
06-GWH34	3/4" FNPT x 3/4" FNPT, 1/2" port	10

Boiler Drain Valves

Forged Boiler Gate Valve

- Brass drain valve.
- Green handle.



Part #	Description	Case Qty
06-BGV12	1/2" MNPT x Hose	5
06-BGV34	3/4" MNPT x Hose	5

Fireplace Forged Gas Ball Valves

- Brass ball valves.
- Red wing handle.
- 600 WOG.



Part #	Description	Case Qty
06-FP1238	1/2" FNPT x 3/8" Male flare	10
06-FP1212	1/2" FNPT x 1/2" Male flare	10
06-FP3458	3/4" FNPT x 5/8" Male flare	10

Appliance Forged Gas Ball Valves

- Brass ball valves.
- Yellow flat head.
- 600 WOG.



Part #	Description	Case Qty
06-FHGV12	1/2" FNPT x 1/2" FNPT, 3/8" port	12
06-FHGV34	3/4" FNPT x 3/4" FNPT, 1/2" port	12

Water Valves

Brass Welded Ball Valves

- Full Port.
- Female sweat connection.
- 600 WOG.
- Green lever handle.



Part #	Description	Case Qty
06-SWV12	1/2" Sweat x 1/2" Sweat	5
06-SWV34	3/4" Sweat x 3/4" Sweat	5

Silicone

Features:

- NSF Approved • 100% Silicone • 100% RTV



302 (GP) General Purpose

- Available in multiple colours.
- The ideal multiple purpose silicone sealant for all weather applications.

Part #	Colour	Size (ml/oz)	Cs. Qty
83-30281	White	83/2.8(squeeze tube)	12
83-30280	Clear	83/2.8(squeeze tube)	12
83-30283	Black	83/2.8(squeeze tube)	12
83-30201	White	300/10.15	12
83-30200	Clear	300/10.15	12
83-30202	Aluminium	300/10.15	12
83-30203	Black	300/10.15	12
83-30205	Almond	300/10.15	12

302 (HT) High Temperature

- Withstands temperatures of 260°C(500°F) constant and 316°C(600°F) intermittent.
- An ideal silicone for extreme temperature applications.



Part #	Colour	Size (ml/oz)	Cs. Qty
83-30289	Red- HT	83/2.8 (Squeeze Tube)	12
83-30293	Black-HT	83/2.8 (Squeeze Tube)	12
83-30209	Red-HT	300/10.15	12
83-30213	Black-HT	300/10.15	12

Epoxy Putty Sticks



Part #	Description	Size	Case Qty
12-451070-24	Fast Steel	3.5"	24
12-457070-24	Quik Aluminum	3.5"	24
12-462570-24	Quik Copper	3.5"	24
12-470570-24	Aquamend	3.5"	24
12-475570-24	Quik Plastic	3.5"	24

Caulking Guns

- 113 Series
- Economy grade.
 - 310ml/10.15oz.
 - Clean out tool on barrel.



15-CG000113

- 138 Series
- Professional grade.
 - 310ml/10.15oz.
 - Clean out tool on handle.



15-CG000138

Shop Rags

Medium Duty Service & Shop Rags
Coloured rags, similar to balbriggan or Polo cotton T-shirt material.

Part #	Description	Weight
13-536-10	10 lbs. service size pack	4.5 kg (10 lbs)

Additional materials and sizes available upon request

Medium Duty

Low cost, no lint, light weight general purpose shop rags. A good general purpose, medium quality wiper at a relatively low cost.



Chimney & Flue Cleaning Brushes

Chimney & Flue Brushes

Chimney/flue cleaning brushes are available in wire for cleaning ceramic flues and chimneys, and poly for cleaning metal flues and chimneys. Choose from a complete range of standard sizes and shapes with 1/4" NPT connectors. Heavy-duty brushes are offered with 3/8" NPT connectors.

MILL-ROSE

Wire Chimney & Flue Brushes

- 1/4" NPT

Part #	Description
61-30600	6" Round
61-30700	7" Round
61-30800	8" Round
61-30900	9" Round
61-31000	10" Round
61-31200	12" Round
61-30606	6" x 6" Square
61-30707	7" x 7" Square
61-30808	8" x 8" Square
61-31010	10" x 10" Square
61-31006	10" x 6" Rectangular
61-31008	10" x 8" Rectangular
61-31107	11" x 7" Rectangular
61-31208	12" x 8" Rectangular

Wire Chimney & Flue Brushes

Heavy-duty wire chimney brushes are designed for professional trade applications.

- Brushes 3/8" NPT.

Part #	Description
61-30601	6" Round
61-30801	8" Round
61-31001	10" Round
61-31401	14" Round
61-30708	7" x 7" Square
61-30809	8" x 8" Square
61-31011	10" x 10" Square
61-31108	11" x 7" Rectangle
61-31205	12" x 8" Rectangle
61-31213	12" x 12" Square

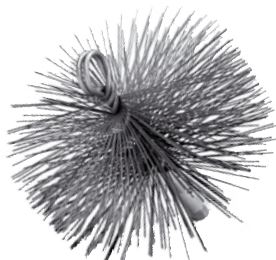

61-30600 illustrated



Standard Packaging



Heavy-Duty Wire Chimney Brushes

Poly Chimney & Flue Brushes

- 1/4" NPT

Part #	Description
61-33110	5" Round
61-33140	6" Round
61-33170	7" Round
61-33190	8" Round
61-33210	12" Round
61-33150	6" x 6" Square
61-33200	8" x 8" Square

Chimney Liner Brushes

- 3/8" NPT, Round, 0.40" Crimped Poly Fill.

Part #	Description	Part #	Description
61-83491	5" Dia. poly	61-83541	8" Dia. poly
61-83521	7" Dia. poly	61-83561	9" Dia. poly
		61-83581	10" Dia. poly

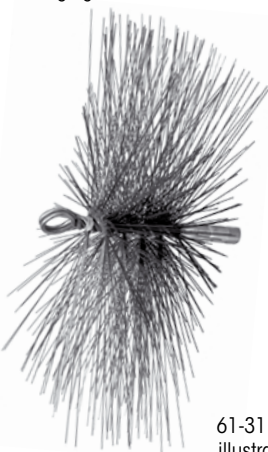

61-31107 illustrated



61-83521 illustrated

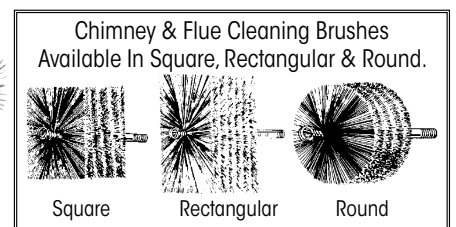

Chimney & Flue Cleaning Brushes Available In Square, Rectangular & Round.



Square



Rectangular



Round

Extension Rods

MILL-ROSE

61-30002
Fiberglass
Extension Rod

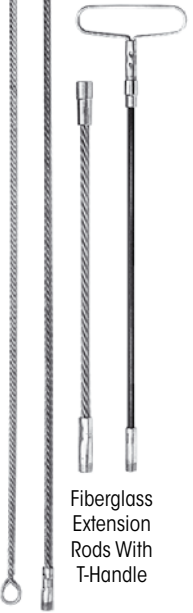

Fiberglass
Extension
Rods With
T-Handle

Twisted Wire
Extension
Rods



Extension Rods

Flue Boiler & Chimney

Flexible, self-connecting fiberglass or twisted wire extension rods with self-connecting 1/4" NPT nipples are available in three convenient lengths; 3', 4' & 6'.

Flue Boiler & Chimney Extension Rods

- Fiberglass/ Steel & Twisted Wire.
- 1/4" NPT 0.34 diameter (fiberglass).

Part #	Description	Length
61-30002	Fiberglass	3'
61-30021	Fiberglass	4'
61-30022	Fiberglass W/ T-Handle (6 pk)	4'
61-30023	Fiberglass (24pk)	4'
61-30061	Fiberglass	6'
61-30071	Fiberglass (24pk)	6'
61-30003	Twisted Wire W/ loop handle	3'
61-30007	Twisted Wire	3'
61-30009	Twisted Wire (24/pk)	3'
61-30031	Twisted Wire	4'
61-30033	Twisted Wire (24/pk)	4'
61-30073	Twisted Wire (24/pk)	6'
• 3/8" NPT self-connect 0.44" diameter.		
61-30035	Fiberglass - Heavy Duty	4'
61-30065	Fiberglass - Heavy Duty	6'

T-Extension Rod Handle

- Used with 1/4" NPT fiberglass or steel extension rods.

Part #	Description
61-70766	Steel Construction: 4" x 2 1/2"

Fiberglass Pellet
Stove Extension Rod



Fiberglass Pellet
Stove Extension Rod
With T-Handle

Pellet Stove Flue Extension Rods

- Fiberglass.
- 5/16"-18 male/female thread.

Part #	Description	Length
61-65010	Fiberglass	2'
61-65015	Fiberglass	3'
61-65000	Fiberglass W/ T-handle	3'
61-65016	Fiberglass	4'
61-65019	Fiberglass - Display Package W/ T-handle (6/pk)	4'
61-65017	Fiberglass	6'
61-65001	T-handle only: 1/2" x 3", 5/16" -18 male/ female thread	-
61-65009	Rod/ brush adapter 5/16-18 to 1/4-20 thread	-

Pellet Stove Flexible Connector

- Designed for pellet stove brush extension rods.
- Attaches to extension rods for 90° bends.

Part #	Description
61-70721	10 3/4" OAL, 5/16"-18 spring connector.
61-70722	13" OAL, std. rod, 1/4" NPT.

Pellet Stove Flue Brushes

Pellet Stove Brushes

Fibre brushes work best for soot removal in pellet stove flues, while stainless steel brushes are more suitable for creosote removal. Brushes and flexible extension rods are designed to negotiate 90° joints in most vent and flues, in many cases without disassembly.

Pellet Stove Brushes

- 1/4" - 20 male/ female thread.
- POP packaged.

Part #	Description
61-84352	3" dia. stainless steel wire
61-84332	3" dia. fibre
61-84372	4" dia. stainless steel wire
61-84333	4" dia. fibre
61-84334	4" dia. fibre pellet stove brush 12' flexible extension rod
61-84380	6" dia. fibre, 1/4-20 coupling
61-84385	8" dia. fibre, 1/4-20 coupling



61-84334
All threaded components
Replacement brush heads
available

Pellet Stove Vent Cleaning Brushes

- 5/16"-18 female thread.

Part #	Description
61-84331	2" Dia. fibre
61-84351	3" Dia. fibre
61-84371	4" Dia. fibre

Maintenance Brushes

Scratch Brushes

- Oil tempered, carbon steel fill wire.
- Extra deep wire staple.
- Hard wooden handles.

Part #	Block Size	Handle Type	Rows	Brush Trim
61-70550	14" x 1 1/8"	Bent	4 x 18	1 3/16"
61-70606	14" x 1"	Bent	3 x 19	1 3/16"
61-70570	10" x 1 1/8"	Shoe	4 x 16	1 3/16"



Blower Flange Dimensions



Part #	Type A				Type B			Type C						Type D				Type E			
	A	B	C	D	E	F	G	H	I	J	K	L	M	N	O	P	Q	R	S	T	U
R7-RB1	3.00"	2.30"	3.00"	2.30"	-	-	-	-	-	-	-	-	-	-	-	-	-	-	-	-	-
R7-RB2	3.00"	2.30"	3.00"	2.30"	-	-	-	-	-	-	-	-	-	-	-	-	-	-	-	-	-
R7-RB3	4.60"	3.90"	3.50"	2.80"	-	-	-	-	-	-	-	-	-	-	-	-	-	-	-	-	-
R7-RB33	3.00"	2.30"	3.00"	2.30"	-	-	-	-	-	-	-	-	-	-	-	-	-	-	-	-	-
R7-RB34	4.5"	3.45"	4.0"	2.85"	-	-	-	-	-	-	-	-	-	-	-	-	-	-	-	-	-
R7-RB60	-	-	-	-	3.3"	2.77"	2.95"	-	-	-	-	-	-	-	-	-	-	-	-	-	-
R7-RB70	4.0"	3.38"	3.5"	2.88"	-	-	-	-	-	-	-	-	-	-	-	-	-	-	-	-	-
R7-RB120	-	-	-	-	4.0"	2.81"	2.33"	-	-	-	-	-	-	-	-	-	-	-	-	-	-
R7-RB141	-	-	-	-	-	-	-	-	-	-	-	-	-	5.13"	4.11"	4.00"	1.50"	-	-	-	-
R7-RB142	-	-	-	-	-	-	-	-	-	-	-	-	-	5.13"	4.11"	4.00"	1.50"	-	-	-	-
HB-RB150	See diagram on page 22																				
R7-RB155	4.0"	3.8"	4.0"	3.3"	-	-	-	-	-	-	-	-	-	-	-	-	-	-	-	-	-
R7-RB160	-	-	-	-	-	-	-	-	-	-	-	-	-	5.13"	4.11"	4.00"	1.50"	-	-	-	-
R7-RB165	3.5"	2.9"	3.9"	3.37"	-	-	-	-	-	-	-	-	-	-	-	-	-	-	-	-	-
R7-RB265	5.5"	4.85"	5.0"	4.4"	-	-	-	-	-	-	-	-	-	-	-	-	-	-	-	-	-
R7-RB320	-	-	-	-	-	-	-	-	-	-	-	-	-	4.75"	4.12"	4.80"	1.47"	-	-	-	-
R7-RB326	-	-	-	-	-	-	-	-	-	-	-	-	-	-	-	-	-	4.42"	5.63"	2.52"	5.02"
R7-RB350	5.3"	4.7"	5.6"	5.0"	-	-	-	-	-	-	-	-	-	-	-	-	-	-	-	-	-
R7-RB440	-	-	-	-	4.04"	2.81"	2.38"	-	-	-	-	-	-	-	-	-	-	-	-	-	-
R7-RB445	6.6"	6.0"	5.7"	5.0"	-	-	-	-	-	-	-	-	-	-	-	-	-	-	-	-	-
R7-RB446	4.61"	3.96"	3.52"	2.87"	-	-	-	-	-	-	-	-	-	-	-	-	-	-	-	-	-
R7-RB447	6.6"	6.0"	5.7"	5.0"	-	-	-	-	-	-	-	-	-	-	-	-	-	-	-	-	-
R7-RB462	-	-	-	-	-	-	-	9.43"	8.8"	4.4"	4.4"	5.0"	4.4"	-	-	-	-	-	-	-	-
R7-RB465	-	-	-	-	-	-	-	9.43"	8.8"	4.4"	4.4"	5.0"	4.4"	-	-	-	-	-	-	-	-
R7-RB495	6.6"	6.0"	5.6"	5.0"	-	-	-	-	-	-	-	-	-	-	-	-	-	-	-	-	-
R7-RB500	6.6"	6.0"	5.6"	5.0"	-	-	-	-	-	-	-	-	-	-	-	-	-	-	-	-	-
R7-RB661	-	-	-	-	3.3"	2.77"	2.36"	-	-	-	-	-	-	-	-	-	-	-	-	-	-
R7-RB662	-	-	-	-	3.3"	2.77"	2.36"	-	-	-	-	-	-	-	-	-	-	-	-	-	-
R7-RB665	-	-	-	-	3.3"	4.00"	2.33"	-	-	-	-	-	-	-	-	-	-	-	-	-	-
R7-RB760	-	-	-	-	-	-	-	9.33"	8.8"	4.4"	4.4"	5.63"	5.06"	-	-	-	-	-	-	-	-
R7-RB938	-	-	-	-	-	-	-	-	-	-	-	-	-	4.75"	4.12"	4.75"	1.50"	-	-	-	-
R7-RB991	3.00"	2.00"	3.00"	2.00"	-	-	-	-	-	-	-	-	-	-	-	-	-	-	-	-	-
HB-RBM121	4.40"	3.75"	4.01"	3.40"	-	-	-	-	-	-	-	-	-	-	-	-	-	-	-	-	-

Diagrams on next page

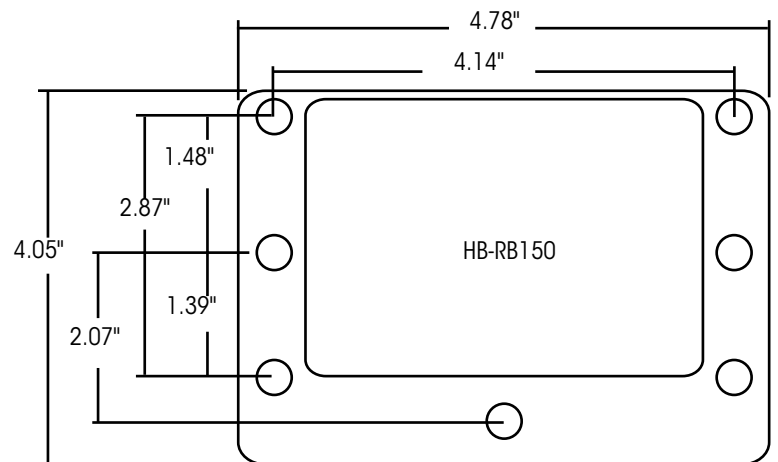
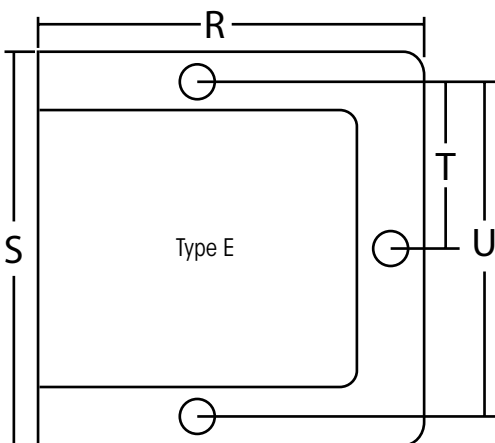
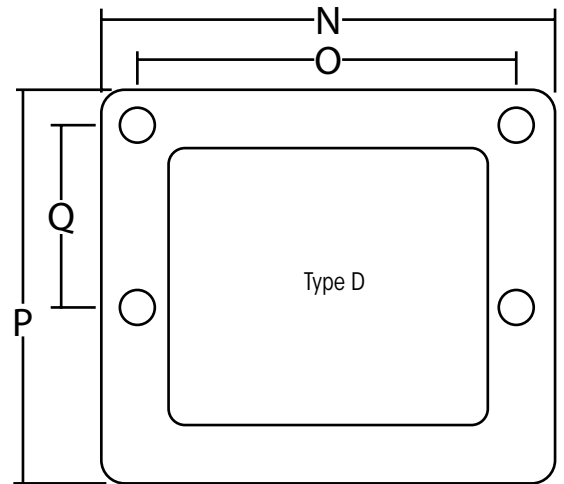
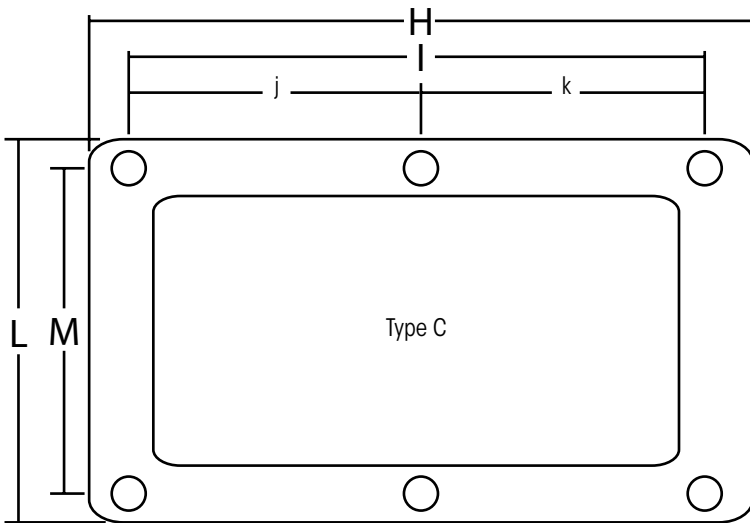
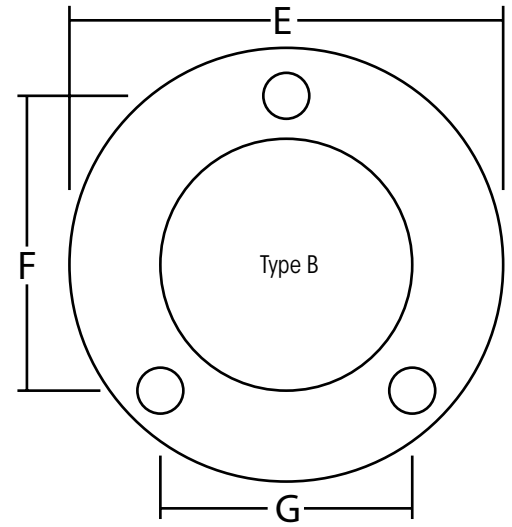
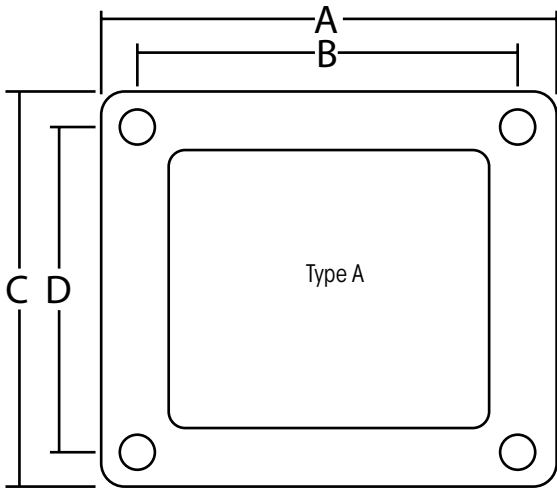

Index

Part #	Pg	Part #	Pg	Part #	Pg	Part #	Pg	Part #	Pg	Part #	Pg
29-159-1	17	61-65010	20	T9-DB10-2	15	HM-R1139	2	HB-RB125	3	T8-RF200	11
29-159-3	17	61-65015	20	T9-DB100C	15	HB-RB006	6	HB-RB130	4	T8-RF201	11
29-159-5	17	61-65016	20	T9-DB144	15	R7-RB1	13	R7-RB141	13	T8-RF202	11
13-536-10	19	61-65017	20	T9-DB204C	15	R7-RB2	12	R7-RB142	13	T8-RF205	11
15-26804	24	61-65019	20	T9-DB205C	15	R7-RB3	6, 12	HB-RB150	9	T8-RF210	11
15-26832	24	61-70550	20	T9-DB206C	15	R7-RB4	12	R7-RB151	13	T8-RF215	11
61-30002	20	61-70570	20	T9-DB208C	15	HB-RB12	5	R7-RB155	2,13	T8-RF220	11
61-30003	20	61-70606	20	T9-DB210C	15	HB-RB21K	3	R7-RB160	13	T8-RF225	11
61-30007	20	61-70721	20	T9-DB212C	15	HB-RB27	8	R7-RB165	13	T8-RF230	11
61-30009	20	61-70722	20	T9-DB306E	15	HB-RB32	7	HB-RB166	5,6,7	T8-RF235	6,7,11
61-30021	20	61-70766	20	T9-DB412E	15	R7-RB33	,7,12	HB-RB167	7	T8-RF236	11
61-30022	20	61-83491	19	T9-DB416P	15	R7-RB34	2,3	HB-RB168	3	T8-RF237	11
61-30023	20	61-83521	19	T9-DF100	16	HB-RB35	4	HB-RB168-1	17	T8-RF240	11
61-30031	20	61-83541	19	T9-DS45110	16	HB-RB36	4	HB-RB168-2	17	T8-RF245	11
61-30033	20	61-83561	19	T9-EQ2	16	HB-RB37	4	HB-RB168B	3	T8-RF247	11
61-30035	20	61-83581	19	O6-FGV1	18	HB-RB38	8	HB-RB179	6	T8-RF248	11
61-30061	20	61-84331	20	O6-FGV1P	18	HB-RB38B	8	R7-RB180	13	T8-RF249	11
61-30065	20	61-84332	20	O6-FGV2P	18	HB-RB38-1	17	HB-RB200T	2	T8-RF250	11
61-30071	20	61-84333	20	O6-FGV12	18	HB-RB39	8	R7-RB245	13	T8-RF255	11
61-30073	20	61-84334	20	O6-FGV12P	18	HB-RB39B	8	HB-RB250	4	HM-RGM450	8
83-30200	18	61-84351	20	O6-FGV34	18	HB-RB41	10	HB-RB261	2	HM-RGM451	8
83-30201	18	61-84352	20	O6-FGV34P	18	HB-RB42	10	R7-RB265	13	HM-RGM452	8
83-30202	18	61-84371	20	O6-FGV38	18	HB-RB45	10	R7-RB266	13	HM-RGM453	8
83-30203	18	61-84372	20	O6-FGV38P	18	HB-RB46	10	HB-RB267	7	HM-RGM454	8
83-30205	18	61-84380	20	O6-FGV112	18	HB-RB50	6	R7-RB312	13	HM-RGM651	8
83-30209	18	61-84385	20	O6-FGV112P	18	HB-RB53	7	R7-RB320	14	78-SC1600L	24
83-30213	18	92-A8301-1	17	O6-FGV114P	18	HB-RB53B	7	R7-RB326	14	78-SC1600VL	24
83-30280	18	92-A8303-1	17	O6-FHG12	18	R7-RB54	13	R7-RB350	14	78-SC1601L	24
83-30281	18	625-AF6	15	O6-FHG34	18	R7-RB55	12	R7-RB428	14	19-SF2-115	17
83-30283	18	625-AF8	15	O6-FP1212	18	HB-RB58	5	R7-RB440	2,12	O6-SVV12	18
83-30289	18	625-AF10	15	O6-FP1238	18	HB-RB58-1	17	R7-RB445	2,14	06-SVV34	18
83-30293	18	625-AF12	15	O6-FP3458	18	HB-RB59	5	R7-RB446	2,13	T9-TW8-2	16
61-30600	19	625-AF14	15	19-FS2-110	17	R7-RB60	12	R7-RB447	2,14	T9-TW208	16
61-30601	19	12-451070-24	19	19-FS2-120	17	HB-RB61	5,10	R7-RB462	14	10-ZS75	10
61-30606	19	12-457070-24	19	19-FS2-130	17	HB-RB63	5	R7-RB465	14		
61-30700	19	12-462570-24	19	19-FS2-160	17	HB-RB64	4,7,10	R7-RB495	14		
61-30707	19	12-470570-24	19	19-FS2-200	17	HB-RB65	5	R7-RB500	14		
61-30708	19	12-475570-24	19	O6-GWH12	18	HB-RB66	10	HB-RB513	6		
61-30800	19	92-A8301	17	O6-GWH34	18	HB-RB67	7	HB-RB555	8		
61-30801	19	92-A8303	17	T9-HC500-W	16	HB-RB67-1	17	HB-RB571	6		
61-30808	19	92-A8305	17	19-LS2-120	17	HB-RB67-2	17	HB-RB611	10		
61-30809	19	92-A8306	17	19-LS2-135	17	HB-RB67-3	17	HB-RB621	5		
61-30900	19	78-ACCWPO3	24	19-LS2-140	17	HB-RB67-5	17	R7-RB661	12		
61-31000	19	78-ACCWPO4	24	19-LS2-145	17	HB-RB68-1	17	R7-RB662	12		
61-31001	19	O6-BGV12	18	19-LS2-150	17	HB-RB68	3	R7-RB663	12		
61-31006	19	O6-BGV34	18	19-LS2-160	17	HB-RB69	10	R7-RB665	12		
61-31008	19	15-C15650	24	19-LS2-165	17	R7-RB70	12	HB-RB735	4		
61-31010	19	15-C23319	24	19-LS2-180	17	HB-RB74K	3	HB-RB755	8		
61-31011	19	15-C26822	24	19-LS2-190	17	HB-RB79	3,10	R7-RB760	14		
61-31107	19	T8-CFC-T24	11	19-LS2-200	17	HB-RB81	7	HB-RB822	10		
61-31108	19	T8-CFC-T24P	11	19-LS2-200F	17	HB-RB82	3,4,10	HB-RB861	7		
61-31200	19	T8-CFC-T48P	11	19-LS2-240	17	HB-RB83	6	R7-RB885	12		
61-31205	19	T8-CFC-T72	11	19-LS2-250	17	HB-RB84	10	R7-RB938	14		
61-31208	19	T8-CFC-T72P	11	19-LS2-275	17	HB-RB85	7	HB-RB939	9		
61-31213	19	T8-CFG-120M	11	19-LS2-290	17	HB-RB86	10	HB-RB944	6,9		
61-31401	19	T8-CFG-120P	11	19-LS2-320	17	HB-RB87	7	HB-RB949	9		
61-33110	19	T8-CFG-150M	11	T9-MD6-NC	15	HB-RB88	7	HB-RB950	9		
61-33140	19	T8-CFG-254M	11	T9-MD6-NO	15	HB-RB89	7	R7-RB965	14		
61-33150	19	T8-CFG-60M	11	T9-MD8-NC	15	R7-RB90	12	HB-RB981	2		
61-33170	19	T8-CFG-80M	11	T9-MD8-NO	15	HB-RB91	4	R7-RB991	12		
61-33190	19	T8-CFG-80P	11	T9-MD10-NC	15	HB-RB94	5	R7-RB1000	14		
61-33200	19	T8-CFG-92M	11	T9-MD10-NO	15	HB-RB95	5	R7-RB1600	14		
61-33210	19	15-CG000113	19	T9-MD12-NC	15	HB-RB96	9	HB-RB6001	4		
61-65000	20	15-CG000138	19	T9-MD12-NO	15	HB-RB100	4	HB-RBM120	9		
61-65001	20	T9-DB6-2CR	15	HM-R489	2	HB-RB108	6	HB-RBM121	9		
61-65009	20	T9-DB8-2	15	HM-R1138	2	R7-RB120	13	T1-RF100-2	5		

**Spray
Nine**

The Tradition of Quality Continues!



From the trusted suppliers of **Spray Nine®** comes the complete cleaning solution to all your seasonal projects. BBQ Grill, Wood Stove and Gas Fireplace, we've got a premium cleaner for all cleaning needs.

Spray Nine® Seasonal Cleaners are available thru Rotom, your single source for Fireview and Gas Fireplace cleaners.

BBQ Grill Cleaner | Complete Barbecue Cleaner

15-C15650 • 650 ml spray bottle • 6/ctn

Spray Nine Premium | Multi-Purpose Cleaner/Degreaser/Disinfectant

15-C26822 • 650 ml spray bottle • 6/ctn

15-26832 • 946 ml spray bottle • 12/ctn

15-26804 • 4L Jug • 4/ctn

Glass & Stainless Steel Cleaner | All-Purpose Glass Cleaner

15-C23319 • 600g aerosol can style • 12/ctn

Fireplace Thermostat



LOGO HERE!
Ask About Our
Private Branding
Program For You
Or Your Customer!

**Who Will Your Customer Call The Next Time
Their Fireplace Or Stove Requires Service?**



78-SC1600L Fireplace Thermostat - Features

- Elegant design.
- Easy to operate.
- Zoning system compatible.
- Adjustable differential.
- Large LCD temperature display.
- Precise temperature sensing.
- Easy access terminal block.
- Freeze protection.
- Compatible with standard 24V AC heating/ cooling systems.
- Integral five minute anti-short cycle protection.
- Mercury free environment safe.
- Manual changeover.
- Battery (included).
- Ideal for electric, gas, oil and hydronic systems.

Millivolt Compatible!
Battery Operated!
Freeze Protected!

Digital Fireplace Thermostat

Part #	Description
78-SC1600L	<ul style="list-style-type: none"> • Non-programmable. • Single stage heat only. • No fan.
78-SC1600VL	
78-ACCWP03	<ul style="list-style-type: none"> • Large insulated thermostat wall plate • Small insulated thermostat wall plate
78-ACCWP04	

*Hard wire model available 78-SC1601L

SC1600 are now C°/F° selectable

ROTOM® is a registered trade mark of ALLTEMP® PRODUCTS COMPANY LIMITED. ALLTEMP® has made an effort to illustrate with photos, outline drawings and/or descriptions, the products in this catalogue. These are for the sole purpose of identification. We do not express or imply that products conform exactly to the descriptions, drawings and/or photos. All reasonable effort has been made to accurately determine a suitable product. However, all users are solely responsible to determine for themselves the suitability of the product purchased for the use intended. All information, data and dimension tables in this catalogue have been carefully compiled and thoroughly checked. However, no responsibility for possible errors or omissions can be assumed. The company reserves the right to change specifications and other information included in this catalogue without notice. The vendor's responsibility shall be limited only to its written warranty and the vendor shall not be responsible for any loss, cost or damage whatsoever from the use of this product by you or your customers.