

4

3

2

1

REVISIONS					
REV	ZONE	DESCRIPTION	EC	NAME	DATE
A01		INITIAL RELEASE			

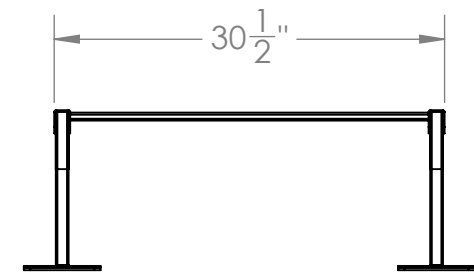
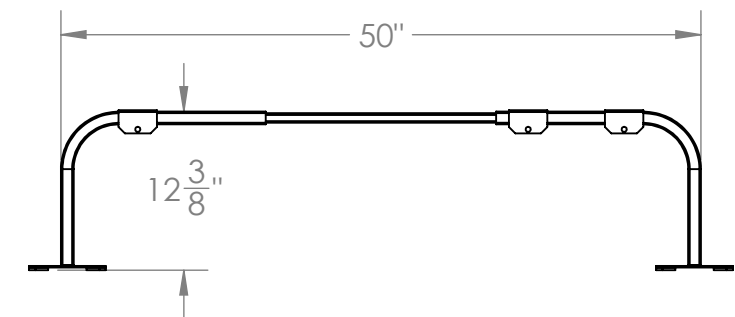
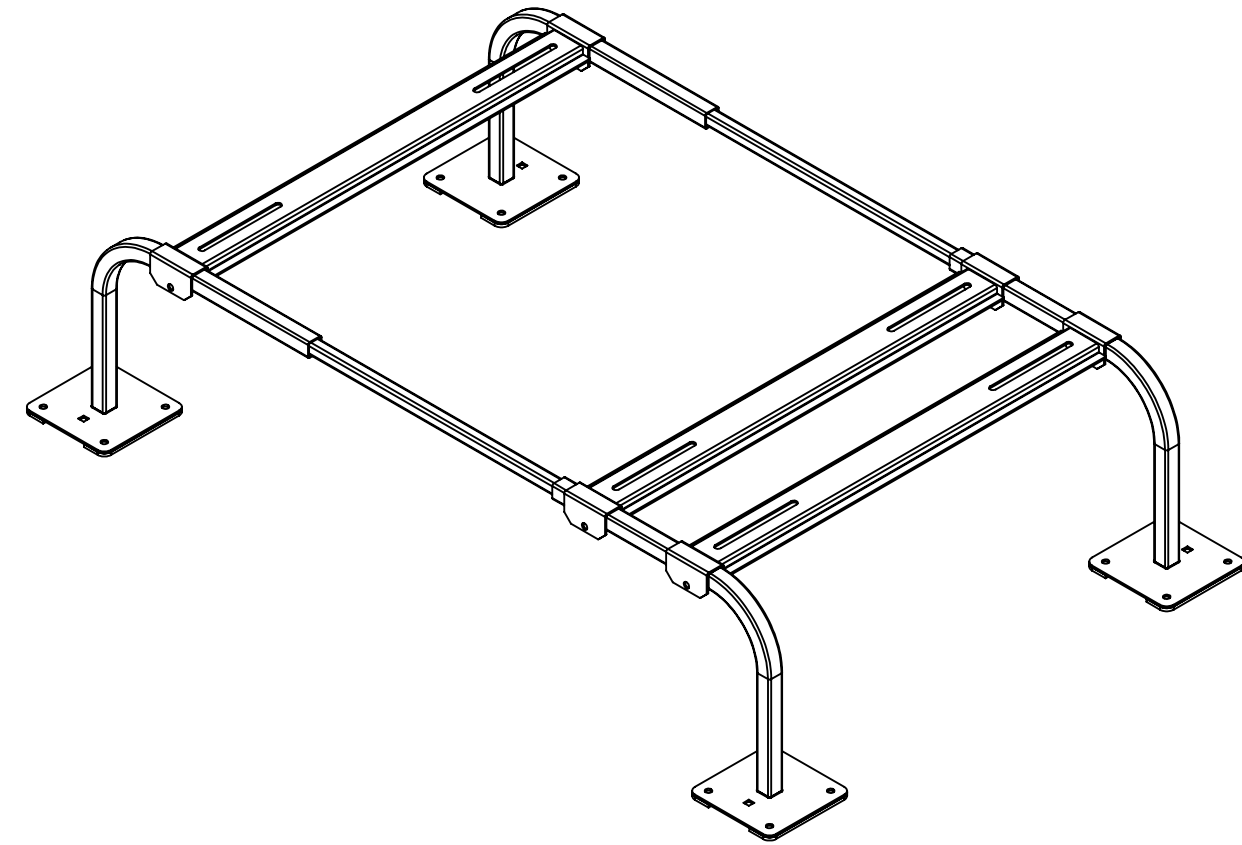
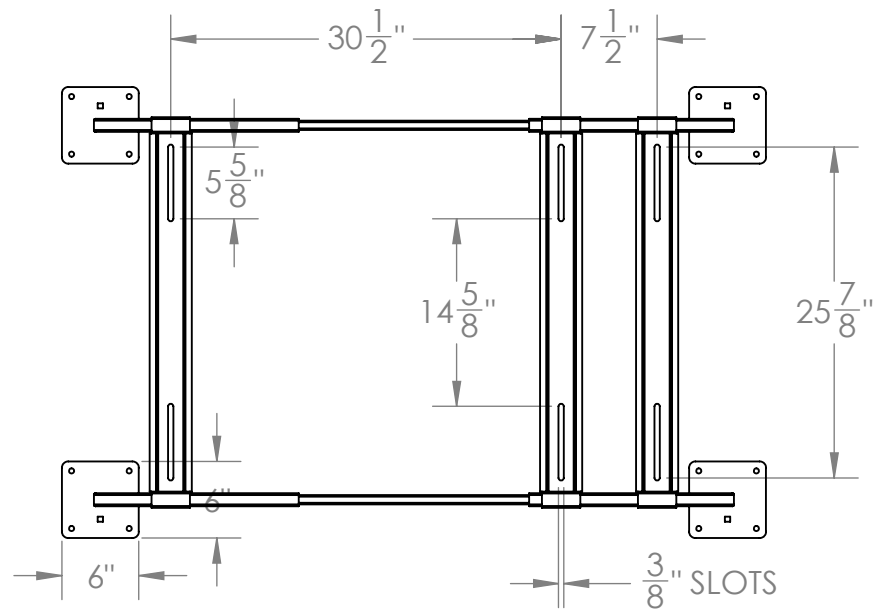

MATERIAL: SEE NOTES
FINISH: SEE NOTES



ALL DRAWINGS AND WRITTEN MATERIAL CONTAINED HEREIN ARE THE PROPERTY OF DIVERSITECH AND MAY NOT BE DUPLICATED OR DISCLOSED AT ANY TIME UNLESS APPROVED IN WRITING BY DIVERSITECH

INTERPRET THIS DRAWING IN ACCORDANCE WITH ASME Y14.5-2009 DIMENSIONING AND TOLERANCING STANDARDS

	NAME	DATE
DRAWN		
CHECKED		
ENG APPR.		
MFG APPR.		
Q.A.		

UNLESS OTHERWISE SPECIFIED
DIMENSIONS ARE IN (INCHES)/MM
TOLERANCES IN MM

ANGULAR MACH	±0.25°
ANGULAR BEND	±1°
X.	±2
X.X	±0.1
X.XX	±0.02
X.XXX	N/A

TITLE: QSMS1205		
SIZE	DRAWING NUMBER	REV
B	QSMS1205	A01
SCALE: 1:20	WEIGHT (lbs):	SHEET 1 OF 1

4

3

2

1